



THE
CEILING FAN
COMPANY

2022
COLLECTION





STYLE IN MOTION

A ceiling fan is a true multi-tasker. Stylish focal point, comfortable breeze maker, beautiful illuminator, even an energy saver when you adjust your heating and cooling system.

Our collection of ceiling fans offers solutions for open areas to cosy bedrooms, grand living rooms to outdoor patios, even commercial and industrial settings.



The Ceiling Fan Company was founded in 2006 and has been the exclusive importer and distributor of Hunter fans in the UAE and Middle East ever since. The Ceiling Fan Company became a subsidiary of the UK-based Elstead Lighting Group in 2019.

We offer a comprehensive selection of ceiling fans, which now includes residential models by Kichler, as well as residential, commercial and industrial fans with dimensions up to 7.7m / 24 ft from Hunter.

Our mission is to ensure that our customers receive excellent products with remarkable service.

OUR PARTNERS





INDOOR LIVING

Add a breath of fresh air to any room. Any size, any finish, any style... this collection turns ceiling fans into focal points you will love looking at in any room.

>> See more on page 19

OUTDOOR LIVING

Keep your cool outside. Our ceiling fans bring style and airflow to your favourite al fresco entertaining spaces. Each offers premium finishes and hardware designed to withstand the elements for years of worry-free performance.

>> See more on page 127



COMMERCIAL AND INDUSTRIAL FANS

Hunter have been making ceiling fans for over 135 years and they put every ounce of their knowledge and technology into every fan. Their commercial and industrial offering is versatile and comes with the assurance of their legacy and superior quality.

>> See more on page 169

TOP THINGS TO CONSIDER WHEN CHOOSING YOUR CEILING FAN

IS THE FAN FOR INSIDE OR OUTSIDE?

There are some restrictions on where a ceiling fan can be placed, depending on how much moisture it will come into contact with. The icons below are used in this catalogue as a quick visual guide to help you know what fan you need.



Indoor (Dry)

All of our indoor / dry fans should be kept to areas where they will not come into contact with water, for example, indoor living spaces and bedrooms.



IP20 (Humid)

Ceiling fans with an IP20 / (Humid) rating can be used in moderate humidity areas, for example, if you have a room that has bi-fold doors that integrates with the outdoors when opened. They cannot withstand direct contact with water.



IP23 (Damp)

Ceiling fans with an IP23 / (Damp) rating can be used in high-humidity areas, like enclosed porches, sunrooms or utility rooms. They feature water-resistant, durable finishes and incorporate galvanised undercoating on all metal surfaces to protect against rusting. Also, their blades are made of either ABS plastic or sealed wood to ensure longevity against damp conditions.



IP44 (Wet)

Ceiling fans with an IP44 (Wet) rating can be used in open areas with direct exposure to sun, rain or water spray, like pergolas and open porches. They have highly durable finishes against rain and snow and include all-weather ABS plastic blades.



WHAT STYLE DO YOU WANT?

We have a variety of different styles and finishes in our collection, designed to fit all needs.

Our modern ceiling fans add a clean, understated look to open spaces. You can choose something more traditional to complement rooms with classic, elegant décor. Or blur the lines with a transitional ceiling fan that is simple and sophisticated with minimal ornamentation.



HOW BIG SHOULD THE FAN BE?

When choosing a ceiling fan, it is important to first identify the area you intend to cool. Always focus a fan over the spaces people will spend most of their time. As in the example below, this may mean two smaller fans will be better than one large one. There are some measurements you should take to be sure that you choose the right size fan, see below for our guidance.

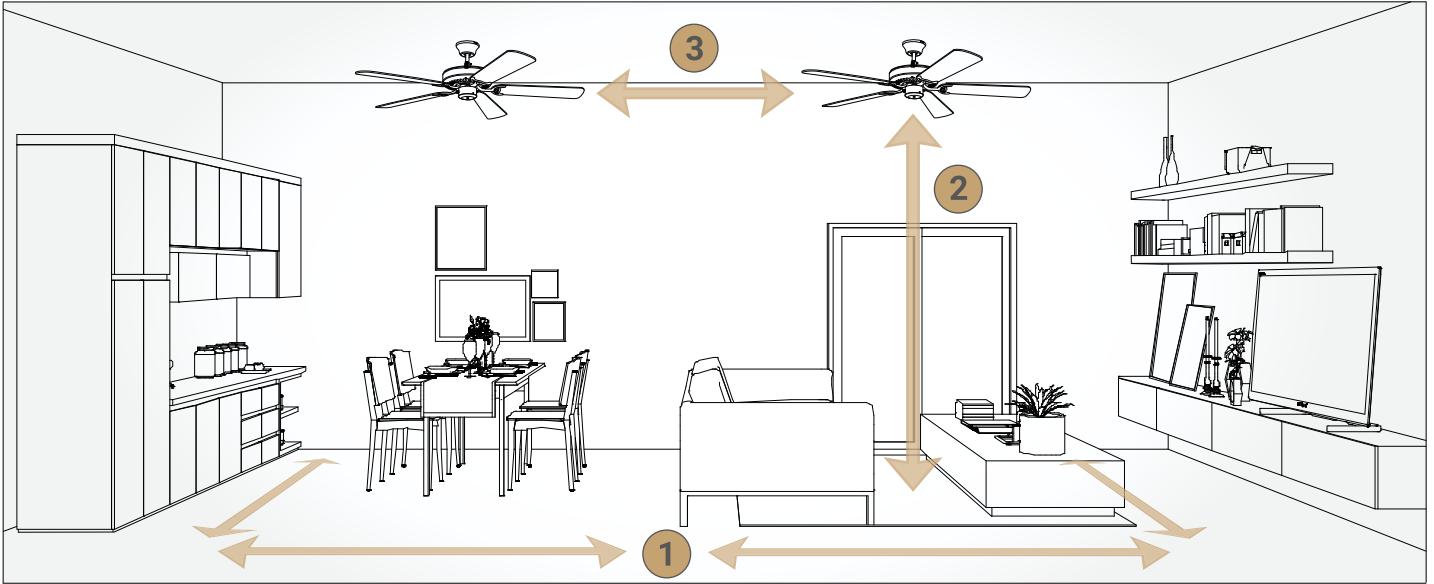

1

Measure the length and the width of the room or space and then multiply e.g. 12ft (3.7m) long by 10ft (3m) wide = 120 square feet. (11.1m²). Once you know the size of your space, you can narrow your search to select size fans. See the table below for guidance.

2

Measure the height of your ceiling. Fans should have a minimum of 7ft (2.1m) clearance between the bottom of the fan blades and the floor. Many of our ceiling fans work with 8ft (2.4m) or 9ft (2.7m) ceilings. If your ceiling is higher, you will need an additional down rod.

3

Bear in mind that all ceiling fans should have at least 12" (30cm) clearance from any wall or object. If you choose to use multiple fans, make sure there is a distance of at least 39" (99cm) between the blade tips of one fan and the next.

ROOM SIZE	ROOM TYPE	BLADE SWEEP
90 sq. ft. (8m ²) or less	Small bedroom or office, galley kitchen, outdoor applications	15" to 42" (38 - 107cm)
90 - 100 sq.ft (8 - 9m ²)	Over a kitchen table, large walk-in closet, laundry room, small screened-in porch, outdoor applications	44" to 48" (112 - 122cm)
100 - 200 sq. ft (9 - 19m ²)	Bedroom, larger kitchen, formal dining room, outdoor applications	50" to 54" (127 - 137cm)
200 - 300 sq. ft (19 - 27.87m ²)	Great room, Large outdoor patio, Master suite, outdoor applications	56" to 65" (142 - 165cm) or multiple fans
Over 300 sq. ft (27.87m ²)	Lobbies, Restaurants, Large open spaces	Over 65" (165cm +) or multiple fans

If planning for an industrial or commercial space, see more guidance on page 182.

ECO-FRIENDLY LIGHTING

You may wish to combine overhead lighting with your ceiling fan. Some of our fans have integrated lights with LED modules that use very little energy.

LED

Look out for the LED symbol on each product page to find these models.

All our other fans that come with lights can take replaceable (retrofit) LED bulbs, so you can choose to make them more eco-friendly.



CUSTOMISATION

Some fans come with 2 sided blades so that you can customise the colour choice when you refresh your home décor.

All semi-flush models can be extended with additional downrods to bring the fan lower in rooms with high ceilings. See **p164** for Kichler downrods and **p166** for Hunter downrods.

REDUCE ENERGY COSTS IN YOUR HOME

CIRCULATE AIR WITH THE SEASONS

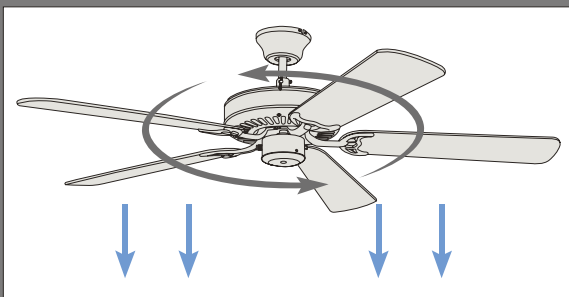

When its hot outside, set the fan to rotate in an **anti-clockwise direction**. The blades will push air down – creating a breeze or cooling effect. A fan can make you feel 4°C cooler than the temperature of your surroundings.

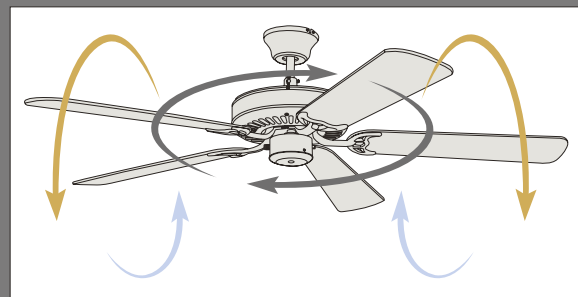

In the winter, set the fan to rotate **clockwise**. The blades will pull the air up and around, moving the warm air that rises to the ceiling back down to the living space.

The effect can help you adjust your thermostat +2.2°C (4°F) during the Summer and -1.1°C (2°F) in the Winter. This makes a fan the only money-saving appliance in your home as it contributes to lower energy costs. (This is not applicable in the same way to outdoor fans.)

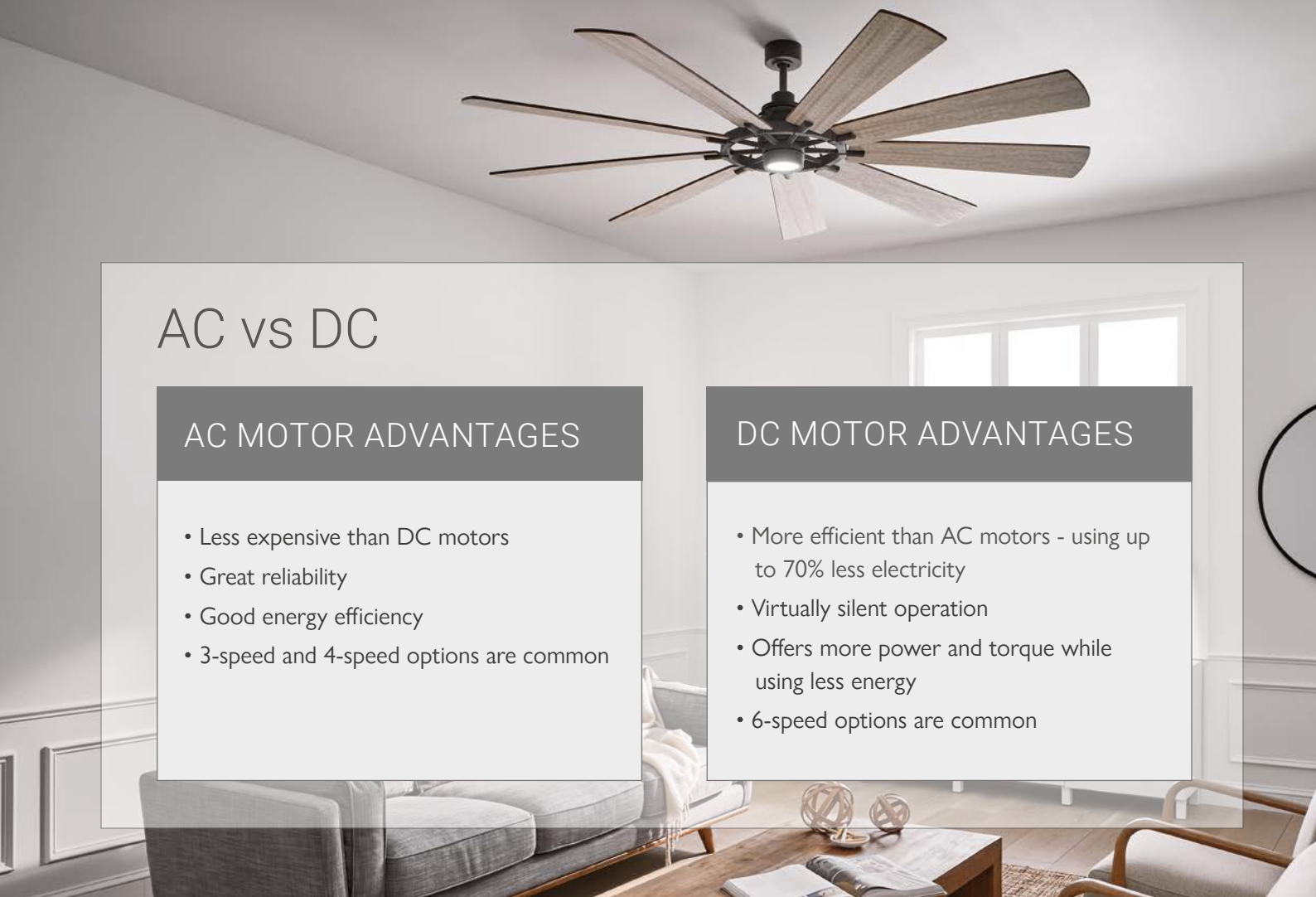

AC vs DC

AC MOTOR ADVANTAGES

- Less expensive than DC motors
- Great reliability
- Good energy efficiency
- 3-speed and 4-speed options are common

DC MOTOR ADVANTAGES

- More efficient than AC motors - using up to 70% less electricity
- Virtually silent operation
- Offers more power and torque while using less energy
- 6-speed options are common

CEILING FAN PERFORMANCE GUIDE

Throughout the catalogue, you will see detailed fan specifications with the table below included. This example is a quick guide to explain what each of the measures mean, and how to spot a fan with the right specifications for you.

AIRFLOW is measured in Cubic Feet per Minute (CFM). The higher the airflow number, the more the air the fan is circulating.

POWER USAGE for your fan motor is measured in watts. The lower the watts, the less energy the fan consumes. DC motor ceiling fans are the most energy-efficient, using the least amount of wattage.

AIRFLOW EFFICIENCY gives you the total picture: dividing the fan's CFMs by the watts of power it consumes. The higher the airflow efficiency number, the more air the fan is moving per watt.

AIR PERFORMANCE	
AIRFLOW Cubic ft. per minute on high	7587
POWER USAGE Watts on High (excludes lights)	34
AIRFLOW EFFICIENCY Cubic ft. per minute per Watt	220



SYMBOL GUIDE

AC

This ceiling fan uses an AC (alternating current) motor.

DC

This ceiling fan uses a DC (direct current) motor, meaning it uses less electricity.



DRY

This ceiling fan can be used in dry indoor locations only.

HUMID



This ceiling fan can withstand damp or humid conditions. It should be used in indoor spaces which might be affected by outdoor conditions.

IP20

This ceiling fan has an IP rating of 20, meaning it is protected against dust and humidity.

DAMP



This ceiling fan can withstand fair outdoor conditions and should be used in sheltered areas. It can still be used indoors.

IP23

This ceiling fan has an IP rating of 23, meaning it is protected against limited exposure to water spray.

WET



This ceiling fan can withstand wet outdoor conditions. It can still be used indoors.

IP44

This ceiling fan has an IP rating of 44, meaning it is protected against splashing water from any angle.

LED

This ceiling fan comes fitted with an LED light source with low energy consumption.

**152
cm**

**60
inch**

This is the bladespan of the ceiling fan - its widest diameter. We provide the measurement in both centimetres and inches for ease of use.



TIME TO CHOOSE YOUR FAN

This table provides a quick glance over the basic details of our residential fans. It will help you quickly decide which is the right fan for you.

For our industrial and commercial fans (Trak, Titan & Eco), see page 168.

Model	Dimensions				Motor Type		Location Rating				Light		Included Accessories		Page No.	
	S	M	L	XL	AC	DC	Outdoor (Wet)	Outdoor (Damp)	Indoor (Humid)	Indoor (Dry)	Integrated LED	Replaceable Bulbs	Remote Control	Wall Control		
Ahrendale			•		•		•					•		•		130
Arcot	•				•						•		•			98
Bayport	•				•						•					112
Builder Elite		•			•						•					68
Cabo Frio		•			•				•					•		90
Canfield	•				•				•							120
Colerne		•			•						•		•			66
Dante	•				•						•		•			108
Eris			•		•		•				•			•		134
Ferron			•			•					•			•		26
Finley	•				•							•		•		116
Gentry				•		•			•		•			•		22
Gentry XL				•		•			•		•			•		20
Harmony		•			•						•		•			54
Hatteras Bay			•		•				•		•			•		50
Imari				•		•			•		•			•		24
Industrie II		•			•						•				•	78
Jade			•		•						•			•		36
Kevlar 42"	•				•		•									158
Kevlar 60"			•		•		•									132
Lehr				•		•	•							•		128
Lehr II		•				•	•							•		142
Link		•				•					•			•		53
Loki		•			•							•		•		86
Low Profile III	•	•			•						•					102
Patio		•			•				•			•		•		148
Maribel		•			•		•									144
Monarch II		•			•						•			•		62
Outdoor Elements II		•			•		•									138 / 150
Phree			•		•				•		•			•		40
Protos		•			•				•						•	82
Ridley II		•			•						•			•		64
Ried			•		•				•					•		44
Savoy		•			•						•					72
Seville II	•				•						•					104
Sola	•				•				•		•			•		160
Sonic		•			•							•		•		58
Stile	•				•							•		•		94
Terna	•				•						•			•		122
Trimaran		•			•		•								•	154
Voya			•			•					•			•		30
Xety			•		•						•			•		46
Zeus			•		•						•			•		32



ARCOT
Brushed Nickel - 117cm
p 101



ARCOT
Fresh White - 117cm
p 99



BAYPORT
Antique Brass - 107cm
p 114



BAYPORT
White - 107cm
p 115



BUILDER ELITE
Brushed Nickel - 132cm
p 69



BUILDER ELITE
New Bronze - 132cm
p 71



BUILDER ELITE
Snow White - 132cm
p 70



COLERNE
Brushed Nickel - 132cm
p 67



DANTE
Brushed Nickel - 112cm
p 110



DANTE
Fresh White - 112cm
p 111



FERRON
Oil Brushed Bronze - 152cm
p 28



FERRON
Polished Nickel - 152cm
p 29



FINLEY
Brushed Nickel - 91cm
p 119



FINLEY
Fresh White - 91cm
p 117



HARMONY
Fresh White - 137cm
p 57



HARMONY
Matte Nickel - 137cm
p 55



HARMONY
Noble Bronze - 137cm
p 56



INDUSTRIE II
Brushed Chrome - 132cm
p 80



INDUSTRIE II
Graphite - 132cm
p 81



INDUSTRIE II
White - 132cm
p 79



JADE - 60"
Antique Pewter - 152cm
p 38



JADE
Brushed Nickel - 152cm
p 39



JADE
Oil Brushed Bronze - 152cm
p 37



LINK
Polished Nickel - 137cm
p 53



LOKI
Brushed Nickel - 132cm
p 88



LOKI
Fresh White - 132cm
p 89



LOKI
Matte Black - 132cm
p 86-87



LOW PROFILE III
White - 132 or 112cm
p 103



MONARCH II
Burnished Antique Pewter - 132cm
p 63



RIDLEY II
Natural Brass - 132cm
p 65



SAVOY
Amber Bronze - 132cm
p 77



SAVOY
Antique Brass - 132cm
p 72



SAVOY
Brushed Nickel - 132cm
p 74



SAVOY
White - 132cm
p 75



SEVILLE II
Antique Brass - 112cm
p 106



SEVILLE II
New Bronze - 112cm
p 107



SEVILLE II
Snow White - 112cm
p 105



SONIC
Brushed Nickel - 132cm
p 61



SONIC
White - 132cm
p 60



STILE
Matte Silver - 117cm
p 96



STILE
Premier Bronze - 117cm
p 97



TERNA
Brushed Nickel - 38cm
p 124



TERNA
Oil Brushed Bronze - 38cm
p 125



VOYA
Brushed Stainless Steel - 152cm
p 31



XETY
Brushed Nickel - 142cm
p 49



XETY
Olde Bronze - 142cm
p 47



ZEUS
Brushed Nickel - 152cm
p 34



ZEUS
White - 152cm
p 35



CABO FRIO
Antique Pewter - 132cm
p 91



CABO FRIO
New Bronze - 132cm
p 92



CABO FRIO
Resort White - 132cm
p 93



CANFIELD
Brushed Nickel - 76cm
p 121



GENTRY XL
Weathered Zinc - 216cm
p 21



GENTRY
Weathered Zinc - 165cm
p 22-23





HATTERAS BAY
Burnished Antique Brass - 142cm
p 51



IMARI
Satin Black - 165cm
p 25



PHREE
Brushed Nickel - 142cm
p 42



PHREE
White - 142cm
p 43



PROTOS
Fresh White - 132cm
p 84



PROTOS
Matt Black - 132cm
p 85



RIED
Anvil Iron - 142cm
p 45





DAMP RATED - These fans can be used in sheltered areas



WET RATED - These fans can withstand wet outdoor conditions



ERIS
Walnut - 152cm
p 136



ERIS
Brushed Nickel - 152cm
p 137



AHRENDALE
Anvil Iron - 152cm
p 131



KEVLAR
Matte White - 152cm
p 133



KEVLAR
Matte White - 107cm
p 159



LEHR
Antique Satin Silver - 203cm
p 129



LEHR II
Antique Satin Silver - 137cm
p 143



LYNDON PATIO
Olde Bronze - 132cm
p 149



MARIBEL
New Bronze - 132cm
p 145



MARIBEL
White - 132cm
p 147





OUTDOOR ELEMENTS II 
New Bronze - 137cm
p 140



OUTDOOR ELEMENTS II 
Raw Aluminum - 137cm
p 141



OUTDOOR ELEMENTS II 
Satin White - 132cm
p 153



OUTDOOR ELEMENTS II 
Weathered Brick - 132cm
p 151



SOLA 
Matte White - 86cm
p 162



SOLA 
Brushed Nickel - 86cm
p 163



TRIMARAN 
Fresh White - 132cm
p 156



TRIMARAN 
Premier Bronze - 132cm
p 157





Image: KLF-FERRON-60-PN - see page 29



INDOOR CEILING FANS

Add a breath of fresh air to any room. Any size, any finish, any style... this collection turns ceiling fans into focal points you will love looking at in any room. There are many unique modern and traditional styles and some very interesting finishes.

CONTENTS

<u>Gentry XL</u>	<u>20</u>	<u>Colerne</u>	<u>66</u>
<u>Gentry</u>	<u>22</u>	<u>Builder Elite</u>	<u>68</u>
<u>Imari</u>	<u>24</u>	<u>Savoy</u>	<u>72</u>
<u>Ferron</u>	<u>26</u>	<u>Industrie II</u>	<u>78</u>
<u>Voya</u>	<u>30</u>	<u>Protos</u>	<u>82</u>
<u>Zeus</u>	<u>32</u>	<u>Loki</u>	<u>86</u>
<u>Jade</u>	<u>36</u>	<u>Cabo Frio</u>	<u>90</u>
<u>Phree</u>	<u>40</u>	<u>Stile</u>	<u>94</u>
<u>Ried</u>	<u>44</u>	<u>Arcot</u>	<u>98</u>
<u>Xety</u>	<u>46</u>	<u>Low Profile III</u>	<u>102</u>
<u>Hatteras Bay</u>	<u>50</u>	<u>Seville II</u>	<u>104</u>
<u>Link</u>	<u>52</u>	<u>Dante</u>	<u>108</u>
<u>Harmony</u>	<u>54</u>	<u>Bayport</u>	<u>112</u>
<u>Sonic</u>	<u>58</u>	<u>Finley</u>	<u>116</u>
<u>Monarch II</u>	<u>62</u>	<u>Canfield</u>	<u>120</u>
<u>Ridley II</u>	<u>64</u>	<u>Terna</u>	<u>122</u>



GENTRY XL

85" / 216cm
bladespan

Massive in scale and size, Gentry knows how to make an impact – both visually and with impressive airflow. The nine-blade design creates a stunning visual effect on or off. Your choice of industrial era-inspired finish combinations provide styles that fit with modern, classic or rustic settings. The dimmable LED light source supplies terrific ambient light.



KICHLER



IP20

LED

DC

85
inch

216
cm

GENTRY XL



KICHLER

Code: KLF-GENTRY-85-WZ

Finish: Weathered Zinc

INCLUDED FEATURES

- Downrods** 1 x 152mm
- Mounting Options** Standard, Angled
- Light Type** 1 x 14W LED, Integrated, Replaceable Module, Dimmable, 3000K, 80 CRI
- Light Output** 1300 lm
- Light Glass** Etched Cased Opal

FAN FEATURES

- Mounting Slope/Pitch** 18°
- Location Rating** IP20 (Humid)
- Hanging Weight** 17kg
- Body Material** Steel
- Warranty** Limited Lifetime

BLADE SPECS

- Blades** (9) included
- Pitch 14°
- Material Wood Veneer

INCLUDED CONTROLS



REMOTE CONTROL

- 6 forward speeds, reverse & motor off
- lights on/off with full-range dimming

MOTOR FEATURES

- Motor Size/Type** DC-165NL, DC
- Amps** 0.21 on High
- RPM (High/Low)** 70/35

Blade Finish



Weathered White Walnut (side 1)



Dark Walnut (side 2)

HANGING MEASUREMENTS

Min. Fixture Drop (from ceiling)	A: 42cm
Min. Blade Drop (from ceiling)	B: 36cm
Housing (width)	C: 18cm
Ceiling Canopy (width)	D: 15cm

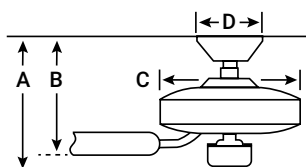

AIR PERFORMANCE

AIRFLOW Cubic ft. per minute on high	8785
POWER USAGE Watts on High (excludes lights)	26.8
AIRFLOW EFFICIENCY Cubic ft. per minute per Watt	300



GENTRY

65" / 165cm
bladespan

Massive in scale and size, Gentry knows how to make an impact – both visually and with impressive airflow. The nine-blade design creates a stunning visual effect on or off. Your choice of industrial era-inspired finish combinations provide styles that fit with modern, classic or rustic settings. The dimmable LED light source supplies terrific ambient light.



IP20

LED

DC

65
inch

165
cm

GENTRY



KICHLER

Code: KLF-GENTRY-65-WZ

Finish: Weathered Zinc

INCLUDED FEATURES

- Downrods** 1 x 152mm
- Mounting Options** Standard, Angled
- Light Type** 1 x 14W LED, Integrated, Replaceable Module, Dimmable, 3000K, 80 CRI
- Light Output** 1300 lm
- Light Glass** Etched Cased Opal

FAN FEATURES

- Mounting Slope/Pitch** 18°
- Location Rating** IP20 (Humid)
- Hanging Weight** 15kg
- Body Material** Steel
- Warranty** Limited Lifetime

BLADE SPECS

- Blades** (9) included
- Pitch** 14°
- Material** Wood Veneer

INCLUDED CONTROLS



REMOTE CONTROL

- 6 forward speeds, reverse & motor off
- lights on/off with full-range dimming

MOTOR FEATURES

- Motor Size/Type** DC-165NL, DC
- Amps** 0.22 on High
- RPM (High/Low)** 124/58

Blade Finish



HANGING MEASUREMENTS

Min. Fixture Drop (from ceiling)	A: 42cm
Min. Blade Drop (from ceiling)	B: 36cm
Housing (width)	C: 18cm
Ceiling Canopy (width)	D: 15cm

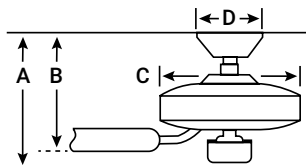

AIR PERFORMANCE

AIRFLOW Cubic ft. per minute on high	7648
POWER USAGE Watts on High (excludes lights)	28.2
AIRFLOW EFFICIENCY Cubic ft. per minute per Watt	237



IMARI

65" / 165cm
bladespan

With a 65-inch blade span, Imari offers airflow to fit the occasion. The propeller inspired single-mold three-blade design creates a clean, sophisticated look. The LED light source provides 1,500 lumens of output – about the equivalent of two 100-watt incandescent light bulbs – for a substantial amount of room-filling ambient light.

KICHLER



IP20

LED

DC

65
inch

165
cm

IMARI



KICHLER

Code: KLF-IMARI-65-SBK

Finish: Satin Black

INCLUDED FEATURES

- Downrods** 1 x 152mm
- Mounting Options** Standard, Angled
- Light Type** 1 x 16W LED, Integrated, Replaceable Module, Dimmable, 3000K, 80 CRI
- Light Output** 1500 lm
- Light Glass** White Polycarbonate

FAN FEATURES

- Mounting Slope/Pitch** 30°
- Location Rating** IP20 (Humid)
- Hanging Weight** 12kg
- Body Material** Steel
- Warranty** Limited Lifetime

BLADE SPECS

Blades (3) included

Pitch	14°
Material	ABS

INCLUDED CONTROLS



REMOTE CONTROL

- 6 forward speeds, reverse & motor off
- lights on/off with full-range dimming

MOTOR FEATURES

- Motor Size/Type** DC-188, DC
- Amps** 0.22 on High
- RPM (High/Low)** 131/54

Blade Finish



Weathered White Walnut (side 1)



Weathered White Walnut (side 2)

HANGING MEASUREMENTS

Min. Fixture Drop (from ceiling)	A: 37cm
Min. Blade Drop (from ceiling)	B: 30cm
Housing (width)	C: 25cm
Ceiling Canopy (width)	D: 16cm

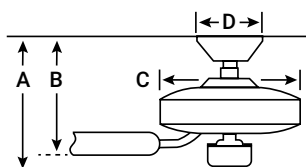

AIR PERFORMANCE

AIRFLOW Cubic ft. per minute on high	9478
POWER USAGE Watts on High (excludes lights)	27.6
AIRFLOW EFFICIENCY Cubic ft. per minute per Watt	282



FERRON

60" / 152cm
bladespan

As sleek and aerodynamic as a high-tech propeller, Ferron employs pure physics to create robust amounts of air. The streamlined motor housing and contoured blades work together to fill a room with style and comfort.





Code: KLF-FERRON-60-BB
Finish: Oil Brushed Bronze

KICHLER

INCLUDED FEATURES

Downrods 1 x 152mm
Mounting Options Standard, Angled

FAN FEATURES

Mounting Slope/Pitch 30°
Location Rating IP20 (Dry)
Hanging Weight 7.6kg
Body Material Steel
Warranty Limited Lifetime

BLADE SPECS

Blades (2) included

Pitch	14°
Material	Polycarbonate

INCLUDED CONTROLS



REMOTE CONTROL

- 6 forward speeds, reverse & motor off

MOTOR FEATURES

Motor Size/Type 125, DC
Amps 0.23 on High
RPM (High/Low) 106/48

Blade Finish

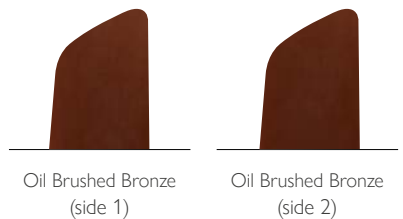

HANGING MEASUREMENTS

Min. Fixture Drop (from ceiling)	A: 41cm
Min. Blade Drop (from ceiling)	B: 39cm
Housing (width)	C: 18cm
Ceiling Canopy (width)	D: 15cm

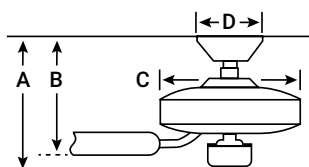

AIR PERFORMANCE

AIRFLOW Cubic ft. per minute on high	5468
POWER USAGE Watts on High (excludes lights)	32.4
AIRFLOW EFFICIENCY Cubic ft. per minute per Watt	167



DC

60
inch

152
cm

FERRON



KICHLER

Code: KLF-FERRON-60-PN
Finish: Polished Nickel

INCLUDED FEATURES

Downrods 1 x 152mm
Mounting Options Standard, Angled

FAN FEATURES

Mounting Slope/Pitch 30°
Location Rating IP20 (Dry)
Hanging Weight 7.6kg
Body Material Steel
Warranty Limited Lifetime

BLADE SPECS

Blades (2) included
Pitch 14°
Material Polycarbonate

INCLUDED CONTROLS



REMOTE CONTROL
• 6 forward speeds,
reverse & motor off

MOTOR FEATURES

Motor Size/Type 125, DC
Amps 0.23 on High
RPM (High/Low) 106/48

Blade Finish

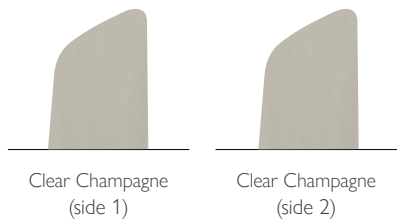

HANGING MEASUREMENTS

Min. Fixture Drop (from ceiling)	A: 41cm
Min. Blade Drop (from ceiling)	B: 39cm
Housing (width)	C: 18cm
Ceiling Canopy (width)	D: 15cm

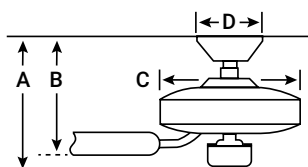

AIR PERFORMANCE	
AIRFLOW Cubic ft. per minute on high	5468
POWER USAGE Watts on High (excludes lights)	32.4
AIRFLOW EFFICIENCY Cubic ft. per minute per Watt	167



VOYA 60" / 152cm bladespan

This Brushed Stainless Steel 60 inch ceiling fan from the Voya collection combines smooth textures and materials in high-tech harmony. Influenced by modern airplane design, the look delivers a smooth breeze in fully aerodynamic fashion.



KICHLER



LED

DC

60
inch

152
cm

VOYA



KICHLER

Code: KLF-VOYA-60-BS

Finish: Brushed Stainless Steel

INCLUDED FEATURES

- Downrods** 1 x 152mm
- Mounting Options** Standard, Angled
- Light Type** 1 x 14W LED, Integrated, Replaceable Module, Dimmable, 3000K, 80 CRI
- Light Output** 1300 lm
- Light Glass** Etched Cased Opal

FAN FEATURES

- Mounting Slope/Pitch** 30°
- Location Rating** IP20 (Dry)
- Hanging Weight** 10.6kg
- Body Material** Polycarbonate
- Warranty** Limited Lifetime

BLADE SPECS

- Blades** (3) included
- Pitch 20°
- Material Polycarbonate

INCLUDED CONTROLS



REMOTE CONTROL

- 6 forward speeds, reverse & motor off
- lights on/off with full-range dimming

MOTOR FEATURES

- Motor Size/Type** 188mm x 10mm, DC
- Amps** 0.22 on High
- RPM (High/Low)** 129/49

Blade Finish



Clear Champagne (side 1)



Clear Champagne (side 2)

HANGING MEASUREMENTS

- Min. Fixture Drop** (from ceiling) **A:** 38cm
- Min. Blade Drop** (from ceiling) **B:** 30cm
- Housing** (width) **C:** 32cm
- Ceiling Canopy** (width) **D:** 18cm

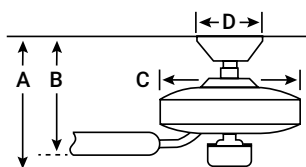

AIR PERFORMANCE

AIRFLOW Cubic ft. per minute on high	7270
POWER USAGE Watts on High (excludes lights)	28
AIRFLOW EFFICIENCY Cubic ft. per minute per Watt	220



ZEUS

60" / 152cm
bladespan

Contrasting polished and matte finishes combine for a powerful visual effect that adds a wow-factor to any large space. The sleek look features blades that are held in place in tandem. Known as "blade irons," this functional – yet unique – metal construction gives the fan a style that works beautifully in contemporary spaces.





Code: KLF-ZEUS-60-BN
Finish: Brushed Nickel

KICHLER

INCLUDED FEATURES

- Downrods** 1 x 114mm
- Mounting Options** Standard, Angled
- Light Type** 1 x 10W LED, Integrated, Replaceable Module, Dimmable, 3000K, 80 CRI
- Light Output** 1116 lm
- Light Glass** White Polycarbonate Lens

FAN FEATURES

- Mounting Slope/Pitch** 30°
- Location Rating** IP20 (Dry)
- Hanging Weight** 11.29kg
- Body Material** Steel
- Warranty** Limited Lifetime

BLADE SPECS

Blades (3) included

Pitch	14°
Material	Wood

Blade Finish

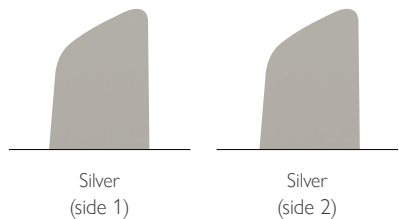

INCLUDED CONTROLS



REMOTE CONTROL

- 3 forward speeds, reverse & motor off
- lights on/off with full-range dimming

MOTOR FEATURES

- Motor Size/Type** 188mm x 25mm, AC
- Amps** 0.406 on High
- RPM (High/Low)** 171/68

HANGING MEASUREMENTS

Min. Fixture Drop (from ceiling)	A: 46cm
Min. Blade Drop (from ceiling)	B: 29cm
Housing (width)	C: 22cm
Ceiling Canopy (width)	D: 15cm

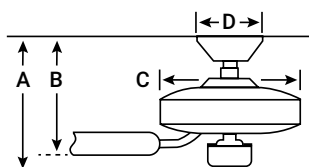

AIR PERFORMANCE

AIRFLOW Cubic ft. per minute on high	6200
POWER USAGE Watts on High (excludes lights)	84.3
AIRFLOW EFFICIENCY Cubic ft. per minute per Watt	74



LED

AC

60
inch

152
cm

ZEUS



KICHLER

Code: KLF-ZEUS-60-WHT
Finish: White

INCLUDED FEATURES

- Downrods** 1 x 114mm
- Mounting Options** Standard, Angled
- Light Type** 1 x 10W LED, Integrated, Replaceable Module, Dimmable, 3000K, 80 CRI
- Light Output** 1116 lm
- Light Glass** White Polycarbonate Lens

FAN FEATURES

- Mounting Slope/Pitch** 30°
- Location Rating** IP20 (Dry)
- Hanging Weight** 11.29kg
- Body Material** Steel
- Warranty** Limited Lifetime

BLADE SPECS

- Blades** (3) included
- Pitch 14°
- Material Wood

INCLUDED CONTROLS



REMOTE CONTROL

- 3 forward speeds, reverse & motor off
- lights on/off with full-range dimming

MOTOR FEATURES

- Motor Size/Type** 188mm x 25mm, AC
- Amps** 0.406 on High
- RPM (High/Low)** 171/68

Blade Finish

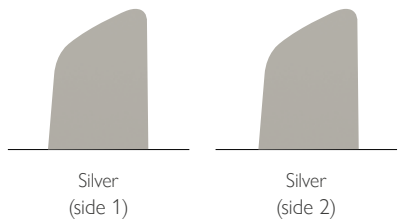

HANGING MEASUREMENTS

Min. Fixture Drop (from ceiling)	A: 46cm
Min. Blade Drop (from ceiling)	B: 29cm
Housing (width)	C: 22cm
Ceiling Canopy (width)	D: 15cm

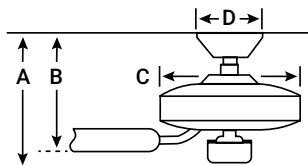

AIR PERFORMANCE	
AIRFLOW Cubic ft. per minute on high	6200
POWER USAGE Watts on High (excludes lights)	84.3
AIRFLOW EFFICIENCY Cubic ft. per minute per Watt	74



JADE 60" / 152cm bladespan

The Japanese art of origami is known for turning a flat plane into a sculpture. Jade's intricately engineered folds work in harmony to move air effectively.



LED

AC

60
inch

152
cm

JADE



KICHLER

Code: KLF-JADE-60-BB
Finish: Oil Brushed Bronze

INCLUDED FEATURES

- Downrods** 1 x 114mm
- Mounting Options** Standard, Angled
- Light Type** 1 x 18W LED, Integrated, Replaceable Module, Dimmable, 3000K, 80 CRI
- Light Output** 1670 lm
- Light Glass** White Polycarbonate

FAN FEATURES

- Mounting Slope/Pitch** 30°
- Location Rating** IP20 (Dry)
- Hanging Weight** 10.5kg
- Body Material** Steel
- Warranty** Limited Lifetime

BLADE SPECS

Blades (3) included

Pitch	12°
Material	ABS

Blade Finish



INCLUDED CONTROLS



REMOTE CONTROL

- 3 forward speeds, reverse & motor off
- lights on/off with full-range dimming

MOTOR FEATURES

- Motor Size/Type** 172mm x 20mm, AC
- Amps** 0.295 on High
- RPM (High/Low)** 161/61

HANGING MEASUREMENTS

Min. Fixture Drop (from ceiling)	A: 35cm
Min. Blade Drop (from ceiling)	B: 32cm
Housing (width)	C: 23cm
Ceiling Canopy (width)	D: 17cm

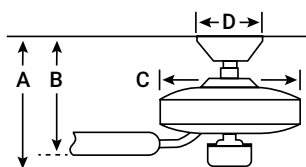

AIR PERFORMANCE	
AIRFLOW Cubic ft. per minute on high	5201
POWER USAGE Watts on High (excludes lights)	60
AIRFLOW EFFICIENCY Cubic ft. per minute per Watt	87



Code: KLF-JADE-60-AP
Finish: Antique Pewter

KICHLER

INCLUDED FEATURES

- Downrods** 1 x 114mm
- Mounting Options** Standard, Angled
- Light Type** 1 x 18W LED, Integrated, Replaceable Module, Dimmable, 3000K, 80 CRI
- Light Output** 1670 lm
- Light Glass** White Polycarbonate

FAN FEATURES

- Mounting Slope/Pitch** 30°
- Location Rating** IP20 (Dry)
- Hanging Weight** 10.5kg
- Body Material** Steel
- Warranty** Limited Lifetime

BLADE SPECS

Blades (3) included

Pitch	12°
Material	ABS

Blade Finish



INCLUDED CONTROLS



REMOTE CONTROL

- 3 forward speeds, reverse & motor off
- lights on/off with full-range dimming

MOTOR FEATURES

- Motor Size/Type** 172mm x 20mm, AC
- Amps** 0.295 on High
- RPM (High/Low)** 161/61

HANGING MEASUREMENTS

Min. Fixture Drop (from ceiling)	A: 35cm
Min. Blade Drop (from ceiling)	B: 32cm
Housing (width)	C: 23cm
Ceiling Canopy (width)	D: 17cm

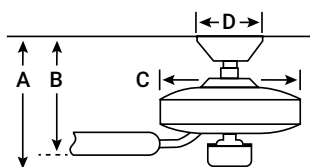

AIR PERFORMANCE

AIRFLOW Cubic ft. per minute on high	5201
POWER USAGE Watts on High (excludes lights)	60
AIRFLOW EFFICIENCY Cubic ft. per minute per Watt	87



LED

AC

60
inch

152
cm

JADE



KICHLER

Code: KLF-JADE-60-BN

Finish: Brushed Nickel

INCLUDED FEATURES

- Downrods** 1 x 114mm
- Mounting Options** Standard, Angled
- Light Type** 1 x 18W LED, Integrated, Replaceable Module, Dimmable, 3000K, 80 CRI
- Light Output** 1670 lm
- Light Glass** White Polycarbonate

FAN FEATURES

- Mounting Slope/Pitch** 30°
- Location Rating** IP20 (Dry)
- Hanging Weight** 10.5kg
- Body Material** Steel
- Warranty** Limited Lifetime

BLADE SPECS

Blades (3) included

Pitch	12°
Material	ABS

Blade Finish

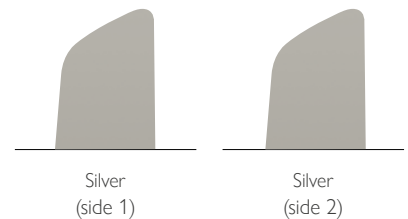

INCLUDED CONTROLS



REMOTE CONTROL

- 3 forward speeds, reverse & motor off
- lights on/off with full-range dimming

MOTOR FEATURES

- Motor Size/Type** 172mm x 20mm, AC
- Amps** 0.295 on High
- RPM (High/Low)** 161/61

HANGING MEASUREMENTS

Min. Fixture Drop (from ceiling)	A: 35cm
Min. Blade Drop (from ceiling)	B: 32cm
Housing (width)	C: 23cm
Ceiling Canopy (width)	D: 17cm

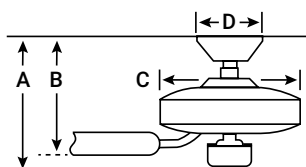

AIR PERFORMANCE

AIRFLOW Cubic ft. per minute on high	5201
POWER USAGE Watts on High (excludes lights)	60
AIRFLOW EFFICIENCY Cubic ft. per minute per Watt	87



PHREE

56" / 142cm
bladespan

Sleek, stylish and solid with a triangular body and precision blades molded into one piece, creating a seamless contemporary design. The dimmable centre light provides a focal point as well as adding whole-room ambient light.





Code: KLF-PHREE-56-BN
Finish: Brushed Nickel



INCLUDED FEATURES

- Downrods** 1 x 114mm
- Mounting Options** Standard, Angled
- Light Type** 1 x 10W LED, Integrated, Replaceable Module, Dimmable, 3000K, 80 CRI
- Light Output** 1116 lm
- Light Glass** Etched Cased Opal

FAN FEATURES

- Mounting Slope/Pitch** 30°
- Location Rating** IP20 (Humid)
- Hanging Weight** 10.57kg
- Body Material** ABS
- Warranty** Limited Lifetime

BLADE SPECS

Blades (3) included

Pitch	22°
Material	ABS

Blade Finish

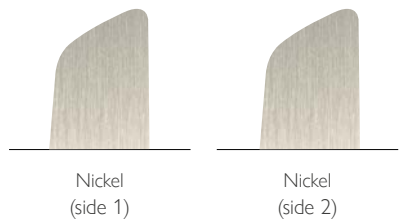

INCLUDED CONTROLS



REMOTE CONTROL

- 3 forward speeds, reverse & motor off
- lights on/off with full-range dimming

MOTOR FEATURES

- Motor Size/Type** 188mm x 20mm, AC
- Amps** 0.305 on High
- RPM (High/Low)** 130/54

HANGING MEASUREMENTS

Min. Fixture Drop (from ceiling)	A: 41cm
Min. Blade Drop (from ceiling)	B: 39cm
Housing (width)	C: 24cm
Ceiling Canopy (width)	D: 17cm

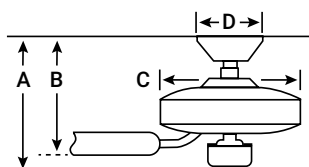

AIR PERFORMANCE

AIRFLOW Cubic ft. per minute on high	6350
POWER USAGE Watts on High (excludes lights)	69.9
AIRFLOW EFFICIENCY Cubic ft. per minute per Watt	91



KICHLER

Code: KLF-PHREE-56-WHT
Finish: White

INCLUDED FEATURES

- Downrods** 1 x 114mm
- Mounting Options** Standard, Angled
- Light Type** 1 x 10W LED, Integrated, Replaceable Module, Dimmable, 3000K, 80 CRI
- Light Output** 1116 lm
- Light Glass** Etched Cased Opal

FAN FEATURES

- Mounting Slope/Pitch** 30°
- Location Rating** IP20 (Humid)
- Hanging Weight** 10.57kg
- Body Material** ABS
- Warranty** Limited Lifetime

BLADE SPECS

- Blades** (3) included
- Pitch 22°
- Material ABS

INCLUDED CONTROLS



REMOTE CONTROL

- 3 forward speeds, reverse & motor off
- lights on/off with full-range dimming

MOTOR FEATURES

- Motor Size/Type** 188mm x 20mm, AC
- Amps** 0.305 on High
- RPM (High/Low)** 130/54

Blade Finish



HANGING MEASUREMENTS

Min. Fixture Drop (from ceiling)	A: 41cm
Min. Blade Drop (from ceiling)	B: 39cm
Housing (width)	C: 24cm
Ceiling Canopy (width)	D: 17cm

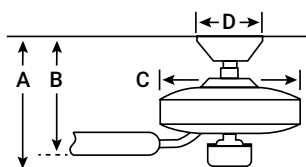

AIR PERFORMANCE	
AIRFLOW Cubic ft. per minute on high	6350
POWER USAGE Watts on High (excludes lights)	69.9
AIRFLOW EFFICIENCY Cubic ft. per minute per Watt	91



RIED

56" / 142cm
bladespan

Get a wood-blade look in a style that works in humid spaces, like a room with bi-fold doors. Ried combines unique wood tones with a rustic-inspired finish for a fan that delivers on the emerging modern industrial trend.

KICHLER



IP20

AC

56
inch

142
cm

RIED



KICHLER

Code: KLF-RIED-56AVI

Finish: Anvil Iron

INCLUDED FEATURES

Downrods 1 x 152mm
Mounting Options Standard, Angled

FAN FEATURES

Mounting Slope/Pitch 22°
Location Rating IP20 (Humid)
Hanging Weight 6.62kg
Body Material Steel
Warranty Limited Lifetime

BLADE SPECS

Blades (3) included

Pitch	14°
Material	ABS

INCLUDED CONTROLS



REMOTE CONTROL

- 3 forward speeds & motor off

MOTOR FEATURES

Motor Size/Type 172mm x 12mm, AC
Amps 0.282 on High
RPM (High/Low) 176/78

Blade Finish



Driftwood (side 1)



Driftwood (side 2)

HANGING MEASUREMENTS

Min. Fixture Drop (from ceiling)	A: 36cm
Min. Blade Drop (from ceiling)	B: 34cm
Housing (width)	C: 20cm
Ceiling Canopy (width)	D: 15cm

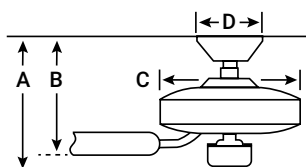

AIR PERFORMANCE

AIRFLOW Cubic ft. per minute on high	6057
POWER USAGE Watts on High (excludes lights)	65.3
AIRFLOW EFFICIENCY Cubic ft. per minute per Watt	93



XETY

56" / 142cm
bladespan

Xety does more with less: the two innovative blades deliver air movement while the dimmable LED light brings brilliant illumination to a space. Authentic industrial hardware enhances the visual interest.



LED

AC

56
inch

142
cm

XETY



KICHLER

Code: KLF-XETY-56-OZ
Finish: Olde Bronze

INCLUDED FEATURES

- Downrods** 1 x 114mm
- Mounting Options** Standard, Angled
- Light Type** 1 x 10W LED, Integrated, Replaceable Module, Dimmable, 3000K, 80 CRI
- Light Output** 1116 lm

FAN FEATURES

- Mounting Slope/Pitch** 30°
- Location Rating** IP20 (Dry)
- Hanging Weight** 9.27kg
- Body Material** Steel
- Warranty** Limited Lifetime

BLADE SPECS

- Blades (2) included**
- Pitch 16°
- Material Polycarbonate

INCLUDED CONTROLS



REMOTE CONTROL

- 3 forward speeds, reverse & motor off
- lights on/off with full-range dimming

MOTOR FEATURES

- Motor Size/Type** 188mm x 20mm, AC
- Amps** 0.294 on High
- RPM (High/Low)** 175/68

Blade Finish

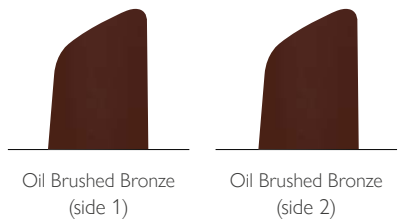

HANGING MEASUREMENTS

Min. Fixture Drop (from ceiling)	A: 35cm
Min. Blade Drop (from ceiling)	B: 28cm
Housing (width)	C: 14cm
Ceiling Canopy (width)	D: 15cm

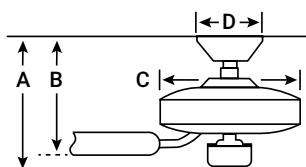

AIR PERFORMANCE	
AIRFLOW Cubic ft. per minute on high	5865
POWER USAGE Watts on High (excludes lights)	68.1
AIRFLOW EFFICIENCY Cubic ft. per minute per Watt	86



XETY 56" / 142cm bladespan

Xety does more with less: the two innovative blades deliver air movement while the dimmable LED light brings brilliant illumination to a space. Authentic industrial hardware enhances the visual interest.



LED

AC

56
inch

142
cm

XETY



KICHLER

Code: KLF-XETY-56-BN
Finish: Brushed Nickel

INCLUDED FEATURES

- Downrods** 1 x 114mm
- Mounting Options** Standard, Angled
- Light Type** 1 x 10W LED, Integrated, Replaceable Module, Dimmable, 3000K, 80 CRI
- Light Output** 1116 lm

FAN FEATURES

- Mounting Slope/Pitch** 30°
- Location Rating** IP20 (Dry)
- Hanging Weight** 9.27kg
- Body Material** Steel
- Warranty** Limited Lifetime

BLADE SPECS

- Blades (2) included**
- Pitch | 16°
- Material | Polycarbonate

INCLUDED CONTROLS



REMOTE CONTROL

- 3 forward speeds, reverse & motor off
- lights on/off with full-range dimming

MOTOR FEATURES

- Motor Size/Type** 188mm x 20mm, AC
- Amps** 0.294 on High
- RPM (High/Low)** 175/68

Blade Finish

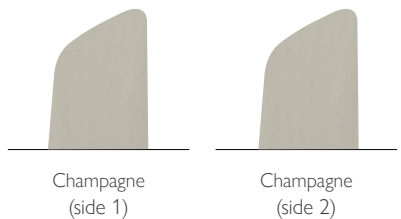

HANGING MEASUREMENTS

Min. Fixture Drop (from ceiling)	A: 35cm
Min. Blade Drop (from ceiling)	B: 28cm
Housing (width)	C: 14cm
Ceiling Canopy (width)	D: 15cm

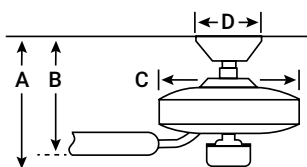

AIR PERFORMANCE	
AIRFLOW Cubic ft. per minute on high	5865
POWER USAGE Watts on High (excludes lights)	68.1
AIRFLOW EFFICIENCY Cubic ft. per minute per Watt	86



HATTERAS BAY

56" / 142cm
bladespan

The 56 inch Hatteras Bay ceiling fan has charming industrial-style details on its Burnished Antique Brass housing, including visible bolts and screws, as well as an era-accurate Fresnel glass shade. This throw-back design is complete with reversible blades offering an option of beautiful Poplar Burl or Elm Burl finishes.



IP20

LED

AC

56
inch

142
cm

HATTERAS BAY



KICHLER

Code: KLF-HATTERAS-BAY-56-BAB

Finish: Burnished Antique Brass

INCLUDED FEATURES

Downrods 1 x 305mm

Mounting Options Standard, Angled

Light Type 1 x 16W LED, Integrated, Replaceable Module, Dimmable, 3000K, 80 CRI

Light Output 1500 lm

Light Glass Fresnel Lens Gloss White Inside-Clear Outside

FAN FEATURES

Mounting Slope/Pitch 22°

Location Rating IP20 (Humid)

Hanging Weight 15kg

Body Material Steel, Plywood, Glass

Warranty Limited Lifetime

BLADE SPECS

Blades (5) included

Pitch 14°

Material ABS

Blade Finish



Poplar Burl (side 1)



Elm Burl (side 2)

INCLUDED CONTROLS



REMOTE CONTROL

- 3 forward speeds, reverse & motor off
- lights on/off with full-range dimming

MOTOR FEATURES

Motor Size/Type 172mm x 20mm, AC

Amps 0.31 on High

RPM (High/Low) 161/68

HANGING MEASUREMENTS

Min. Fixture Drop (from ceiling) **A:** 57cm

Min. Blade Drop (from ceiling) **B:** 18cm

Housing (width) **C:** 39cm

Ceiling Canopy (width) **D:** 17cm

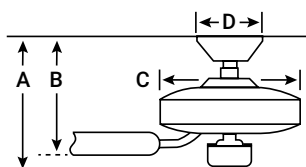

AIR PERFORMANCE

AIRFLOW
Cubic ft. per minute on high **7071**

POWER USAGE
Watts on High (excludes lights) **71.6**

AIRFLOW EFFICIENCY
Cubic ft. per minute per Watt **75**



LINK

54" / 137cm
bladespan

With a unique centre ring, the dual blades of the Link fan seem to flow into one seamless piece. In motion, Link moves a generous amount of air while creating an orbital focal piece.

KICHLER



DC

54
inch

137
cm

LINK



KICHLER

Code: KLF-LINK-54-PN
Finish: Polished Nickel

INCLUDED FEATURES

Downrods Not Available
Mounting Options Flush

FAN FEATURES

Location Rating IP20 (Dry)
Hanging Weight 8.5kg
Body Material Steel
Warranty Limited Lifetime

BLADE SPECS

Blades (2) included

Pitch	28°
Material	ABS

INCLUDED CONTROLS



REMOTE CONTROL

- 6 forward speeds, reverse & motor off

MOTOR FEATURES

Motor Size/Type 125, DC
Amps 0.24 on High
RPM (High/Low) 134/60

Blade Finish



Walnut (side 1)

Walnut (side 2)

HANGING MEASUREMENTS

Min. Fixture Drop (from ceiling)	A: 62cm
Min. Blade Drop (from ceiling)	B: 62cm
Housing (width)	C: 20cm
Ceiling Canopy (width)	D: 20cm

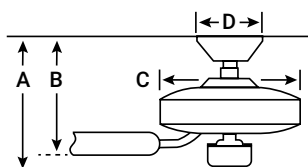

AIR PERFORMANCE	
AIRFLOW Cubic ft. per minute on high	6523
POWER USAGE Watts on High (excludes lights)	32.4
AIRFLOW EFFICIENCY Cubic ft. per minute per Watt	184



HARMONY

54" / 137cm
bladespan

With graceful, sweeping blades, elegant lines and a choice of three finishes, the Harmony is a soft modern masterpiece perfect for your large indoor living spaces. A remote control is included with this ceiling fan which controls the dimmable light source to create the perfect ambiance.

Hunter



AC

54
inch

137
cm

HARMONY



Code: HT-50625
Finish: Matte Nickel

INCLUDED FEATURES

- Downrods** 1 x 51mm
- Mounting Options** Standard, Angled, Flush
- Light Type** 2 x 40W E27, Dimmable Bulbs Recommended (Not Included)
- Light Glass** Painted Cased White

FAN FEATURES

- Mounting Slope/Pitch** 35°
- Location Rating** (Dry)
- Hanging Weight** 8.9kg
- Body Material** Cold Rolled Steel
- Warranty** Limited Lifetime Motor

BLADE SPECS

Blades (3) included	
Pitch	variable°
Material	Plastic

INCLUDED CONTROLS



REMOTE CONTROL

- 3 forward speeds & motor off
- lights on/off with full-range dimming

MOTOR FEATURES

- Motor Size/Type** 172mm x 20mm, AC
- Amps** 0.265 on High
- RPM (High/Low)** 208/107

Blade Finish

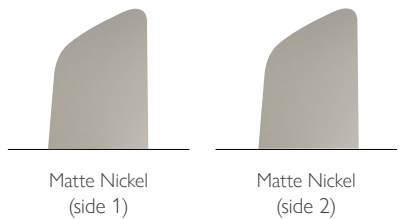

HANGING MEASUREMENTS

Min. Fixture Drop (from ceiling)	A: 34.5cm
Min. Blade Drop (from ceiling)	B: 27.7cm
Housing (width)	C: 20.6cm
Ceiling Canopy (width)	D: 16.5cm

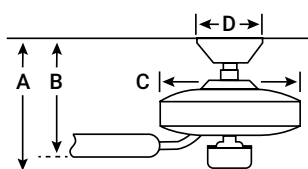

AIR PERFORMANCE	
AIRFLOW Cubic ft. per minute on high	6124
POWER USAGE Watts on High (excludes lights)	68
AIRFLOW EFFICIENCY Cubic ft. per minute per Watt	71



Code: HT-50964

Finish: Noble Bronze



INCLUDED FEATURES

- Downrods** 1 x 51mm
- Mounting Options** Standard, Angled, Flush
- Light Type** 2 x 40W E27, Dimmable Bulbs Recommended (Not Included)
- Light Glass** Painted Cased White

FAN FEATURES

- Mounting Slope/Pitch** 35°
- Location Rating** (Dry)
- Hanging Weight** 8.9kg
- Body Material** Cold Rolled Steel
- Warranty** Limited Lifetime Motor

BLADE SPECS

Blades (3) included

Pitch	variable°
Material	Plastic

Blade Finish



INCLUDED CONTROLS



REMOTE CONTROL

- 3 forward speeds & motor off
- lights on/off with full-range dimming

MOTOR FEATURES

- Motor Size/Type** 172mm x 20mm, AC
- Amps** 0.265 on High
- RPM (High/Low)** 208/107

HANGING MEASUREMENTS

Min. Fixture Drop (from ceiling)	A: 34.5cm
Min. Blade Drop (from ceiling)	B: 27.7cm
Housing (width)	C: 20.6cm
Ceiling Canopy (width)	D: 16.5cm

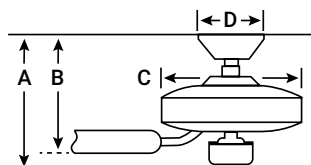

AIR PERFORMANCE

AIRFLOW Cubic ft. per minute on high	6124
POWER USAGE Watts on High (excludes lights)	68
AIRFLOW EFFICIENCY Cubic ft. per minute per Watt	71



AC

54
inch

137
cm

HARMONY



Code: HT-50626
Finish: Fresh White

INCLUDED FEATURES

- Downrods** 1 x 51mm
- Mounting Options** Standard, Angled, Flush
- Light Type** 2 x 40W E27, Dimmable Bulbs Recommended (Not Included)
- Light Glass** Painted Cased White

FAN FEATURES

- Mounting Slope/Pitch** 35°
- Location Rating** (Dry)
- Hanging Weight** 8.9kg
- Body Material** Cold Rolled Steel
- Warranty** Limited Lifetime Motor

BLADE SPECS

Blades (3) included	
Pitch	variable°
Material	Plastic

INCLUDED CONTROLS



REMOTE CONTROL

- 3 forward speeds & motor off
- lights on/off with full-range dimming

MOTOR FEATURES

- Motor Size/Type** 172mm x 20mm, AC
- Amps** 0.265 on High
- RPM (High/Low)** 208/107

Blade Finish

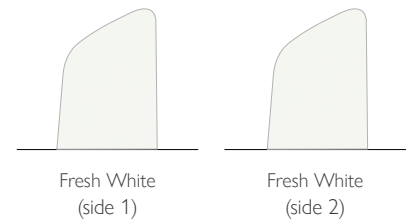

HANGING MEASUREMENTS

Min. Fixture Drop (from ceiling)	A: 34.5cm
Min. Blade Drop (from ceiling)	B: 27.7cm
Housing (width)	C: 20.6cm
Ceiling Canopy (width)	D: 16.5cm

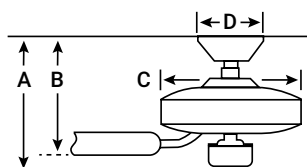

AIR PERFORMANCE

AIRFLOW Cubic ft. per minute on high	6124
POWER USAGE Watts on High (excludes lights)	68
AIRFLOW EFFICIENCY Cubic ft. per minute per Watt	71



SONIC

52" / 132cm
bladespan

The smooth globe body and 132cm blades of the Sonic fan make it a perfect fit in your large rooms with a unique home decor style. This Hunter® ceiling fan is available in a simple and sophisticated Brushed Nickel or White finish.





Code: HT-50666
Finish: White



INCLUDED FEATURES

- Downrods** 1 x 102mm
- Mounting Options** Standard, Angled
- Light Type** 2 x 20W E27, Dimmable Bulbs Recommended (Not Included)
- Light Glass** Painted Cased White

FAN FEATURES

- Mounting Slope/Pitch** 35°
- Location Rating** (Dry)
- Hanging Weight** 9.4kg
- Body Material** Cold Rolled Steel
- Warranty** Limited Lifetime Motor

BLADE SPECS

- Blades** (4) included
- Pitch | 12°
- Material | Composite

INCLUDED CONTROLS



- REMOTE CONTROL**
- 3 forward speeds & motor off
 - lights on/off with full-range dimming

MOTOR FEATURES

- Motor Size/Type** 172mm x 20mm, AC
- RPM (High)** 210

Blade Finish

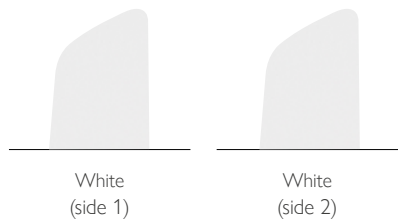

HANGING MEASUREMENTS

Min. Fixture Drop (from ceiling)	A: 37cm
Min. Blade Drop (from ceiling)	B: 25.9cm
Housing (width)	C: 27.1cm
Ceiling Canopy (width)	D: 16.5cm

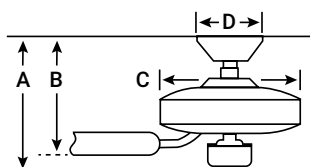

AIR PERFORMANCE	
AIRFLOW Cubic ft. per minute on high	5709
POWER USAGE Watts on High (excludes lights)	61
AIRFLOW EFFICIENCY Cubic ft. per minute per Watt	94



AC

52
inch

132
cm

SONIC



Hunter

Code: HT-50665

Finish: Brushed Nickel

INCLUDED FEATURES

Downrods 1 x 102mm

Mounting Options Standard, Angled

Light Type 2 x 20W E27, Dimmable Bulbs Recommended (Not Included)

Light Glass Painted Cased White

FAN FEATURES

Mounting Slope/Pitch 35°

Location Rating (Dry)

Hanging Weight 9.4kg

Body Material Cold Rolled Steel

Warranty Limited Lifetime Motor

BLADE SPECS

Blades (4) included

Pitch | 12°

Material | Composite

Blade Finish

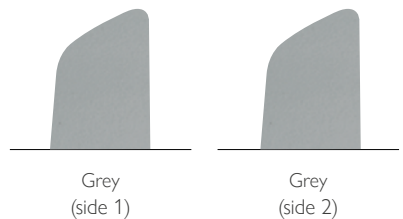

INCLUDED CONTROLS



REMOTE CONTROL

- 3 forward speeds & motor off
- lights on/off with full-range dimming

MOTOR FEATURES

Motor Size/Type 172mm x 20mm, AC

RPM (High) 210

HANGING MEASUREMENTS

Min. Fixture Drop (from ceiling) **A:** 37cm

Min. Blade Drop (from ceiling) **B:** 25.9cm

Housing (width) **C:** 27.1cm

Ceiling Canopy (width) **D:** 16.5cm

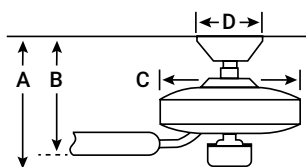

AIR PERFORMANCE

AIRFLOW
Cubic ft. per minute on high **5709**

POWER USAGE
Watts on High (excludes lights) **61**

AIRFLOW EFFICIENCY
Cubic ft. per minute per Watt **94**



MONARCH II

52" / 132cm
bladespan

Featuring clean lines, textured accents, and a beautiful Burnished Antique Pewter finish, this 52 inch Monarch™ II ceiling fan will effortlessly complement the existing décor in your home.



AC

52
inch

132
cm

MONARCH II



KICHLER

Code: KLF-MONARCH2-52-BAP

Finish: Burnished Antique Pewter

INCLUDED FEATURES

Downrods 1 x 102mm
Mounting Options Standard, Angled

FAN FEATURES

Mounting Slope/Pitch 18°
Location Rating IP20 (Dry)
Hanging Weight 9.4kg
Body Material Steel
Warranty Limited Lifetime

BLADE SPECS

Blades (5) included
Pitch | 14°
Material | Wood

INCLUDED CONTROLS



REMOTE CONTROL

- 3 forward speeds, reverse & motor off

MOTOR FEATURES

Motor Size/Type 172mm x 17mm, AC
Amps 0.29 on High
RPM (High/Low) 157/68

Blade Finish



Dark Cherry (side 1)



Weathered White Walnut (side 2)

HANGING MEASUREMENTS

Min. Fixture Drop (from ceiling)	A: 34cm
Min. Blade Drop (from ceiling)	B: 32cm
Housing (width)	C: 35cm
Ceiling Canopy (width)	D: 17cm

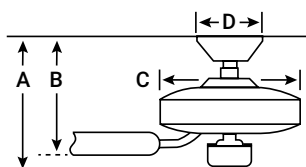

AIR PERFORMANCE

AIRFLOW Cubic ft. per minute on high	5120
POWER USAGE Watts on High (excludes lights)	66.3
AIRFLOW EFFICIENCY Cubic ft. per minute per Watt	67



RIDLEY II

52" / 132cm
bladespan

The 52 inch Ridley II ceiling fan combines Natural Brass and Solid Cherry Wood blades with a minimalist styling that will impact any space in your home. The Integrated LED light at its core is a convenient and energy efficient way to illuminate your space.



LED

AC

52
inch

132
cm

RIDLEY II



KICHLER

Code: KLF-RIDLEY2-52-NB

Finish: Natural Brass

INCLUDED FEATURES

- Downrods** 1 x 114mm
- Mounting Options** Standard, Angled
- Light Type** 1 x 14W LED, Integrated, Replaceable Module, Dimmable, 3000K, 80 CRI
- Light Output** 1300 lm
- Light Glass** Etched Cased Opal

FAN FEATURES

- Mounting Slope/Pitch** 30°
- Location Rating** IP20 (Dry)
- Hanging Weight** 7.8kg
- Body Material** Steel
- Warranty** Limited Lifetime

BLADE SPECS

Blades (3) included	
Pitch	14°
Material	Solid Wood

INCLUDED CONTROLS



REMOTE CONTROL

- 3 forward speeds, reverse & motor off
- lights on/off with full-range dimming

MOTOR FEATURES

- Motor Size/Type** 153mm x 18mm, AC
- Amps** 0.25 on High
- RPM (High/Low)** 137/69

Blade Finish



Cherry (side 1)



Cherry (side 2)

HANGING MEASUREMENTS

Min. Fixture Drop (from ceiling)	A: 41cm
Min. Blade Drop (from ceiling)	B: 34cm
Housing (width)	C: 17cm
Ceiling Canopy (width)	D: 15cm

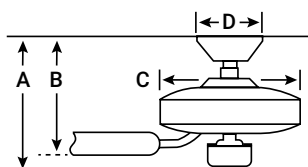

AIR PERFORMANCE

AIRFLOW Cubic ft. per minute on high	5124
POWER USAGE Watts on High (excludes lights)	57.2
AIRFLOW EFFICIENCY Cubic ft. per minute per Watt	87



COLERNE

52" / 132cm
bladespan

You'll love the vintage industrial feel that Colerne brings to a space. Wood-tone blades create the look of rustic wood, while metal accents deliver a style that's equally at home in farmhouse or modern settings. Integrated, dimmable LED downlighting allows you to fill a space with just the right amount of light.

KICHLER



LED

AC

52
inch

132
cm

COLERNE



KICHLER

Code: KLF-COLERNE-52-BN

Finish: Brushed Nickel

INCLUDED FEATURES

- Downrods** 1 x 152mm
- Mounting Options** Standard, Angled
- Light Type** 1 x 10W LED, Integrated, Replaceable Module, Dimmable, 3000K, 80 CRI
- Light Output** 1116 lm
- Light Glass** Etched Cased Opal

FAN FEATURES

- Mounting Slope/Pitch** 30°
- Location Rating** IP20 (Dry)
- Hanging Weight** 10.3kg
- Body Material** Steel
- Warranty** Limited Lifetime

BLADE SPECS

- Blades** (5) included
- Pitch 12°
- Material Wood

INCLUDED CONTROLS



REMOTE CONTROL

- 3 forward speeds, reverse & motor off
- lights on/off with full-range dimming

MOTOR FEATURES

- Motor Size/Type** 172mm x 15mm, AC
- Amps** 0.256 on High
- RPM (High/Low)** 175/78

Blade Finish



HANGING MEASUREMENTS

Min. Fixture Drop (from ceiling)	A: 43cm
Min. Blade Drop (from ceiling)	B: 32cm
Housing (width)	C: 24cm
Ceiling Canopy (width)	D: 18cm

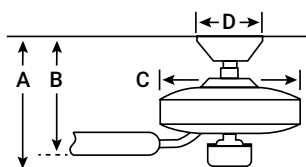

AIR PERFORMANCE

AIRFLOW Cubic ft. per minute on high	5190
POWER USAGE Watts on High (excludes lights)	59.2
AIRFLOW EFFICIENCY Cubic ft. per minute per Watt	88



BUILDER ELITE

52" / 132cm
bladespan

Hunter combines 19th century craftsmanship with 21st century design and technology to create ceiling fans of unmatched quality, style, and whisper-quiet performance. Using the finest materials to create stylish designs, Hunter ceiling fans work beautifully in today's homes and can save up to 47% on cooling costs!

Hunter



AC

52
inch

132
cm

BUILDER ELITE



Code: HT-50566

Finish: Brushed Nickel

INCLUDED FEATURES

Downrods 1 x 76mm
Mounting Options Standard, Angled
Light kit Adaptable (see page 165)

FAN FEATURES

Mounting Slope/Pitch 35°
Location Rating (Dry)
Hanging Weight 7.3kg
Body Material Cold Rolled Steel
Warranty Limited Lifetime Motor

BLADE SPECS

Blades (5) included
Pitch 13°
Material Composite

INCLUDED CONTROLS



PULL CHAIN

- 3 forward speeds & motor off

MOTOR FEATURES

Motor Size/Type 172mm x 12mm, AC
Amps 0.275 on High
RPM (High/Low) 159/74

Blade Finish

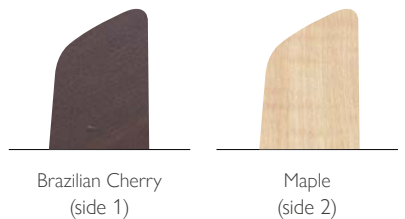

HANGING MEASUREMENTS

Min. Fixture Drop (from ceiling)	A: 31.3cm
Min. Blade Drop (from ceiling)	B: 27.9cm
Housing (width)	C: 27.7cm
Ceiling Canopy (width)	D: 16.5cm

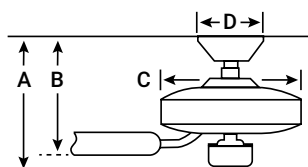

AIR PERFORMANCE	
AIRFLOW Cubic ft. per minute on high	4844
POWER USAGE Watts on High (excludes lights)	65
AIRFLOW EFFICIENCY Cubic ft. per minute per Watt	74



Code: HT-50565
Finish: Snow White



INCLUDED FEATURES

Downrods 1 x 76mm
Mounting Options Standard, Angled
Light kit Adaptable (see page 165)

FAN FEATURES

Mounting Slope/Pitch 35°
Location Rating (Dry)
Hanging Weight 7.3kg
Body Material Cold Rolled Steel
Warranty Limited Lifetime Motor

BLADE SPECS

Blades (5) included
Pitch | 13°
Material | Composite

INCLUDED CONTROLS



PULL CHAIN
• 3 forward speeds & motor off

MOTOR FEATURES

Motor Size/Type 172mm x 12mm, AC
Amps 0.275 on High
RPM (High/Low) 159/74

Blade Finish

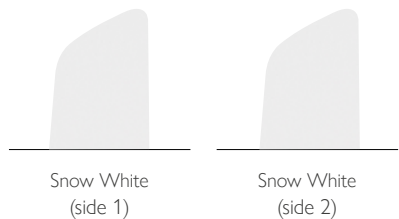

HANGING MEASUREMENTS

Min. Fixture Drop (from ceiling)	A: 31.3cm
Min. Blade Drop (from ceiling)	B: 27.9cm
Housing (width)	C: 27.7cm
Ceiling Canopy (width)	D: 16.5cm

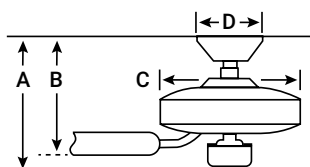

AIR PERFORMANCE

AIRFLOW Cubic ft. per minute on high	4844
POWER USAGE Watts on High (excludes lights)	65
AIRFLOW EFFICIENCY Cubic ft. per minute per Watt	74



AC

52
inch

132
cm

BUILDER ELITE



Hunter

Code: HT-50567

Finish: New Bronze

INCLUDED FEATURES

Downrods 1 x 76mm
Mounting Options Standard, Angled
Light kit Adaptable (see page 165)

FAN FEATURES

Mounting Slope/Pitch 35°
Location Rating (Dry)
Hanging Weight 7.3kg
Body Material Cold Rolled Steel
Warranty Limited Lifetime Motor

BLADE SPECS

Blades (5) included
Pitch 13°
Material Composite

INCLUDED CONTROLS



PULL CHAIN
• 3 forward speeds & motor off

MOTOR FEATURES

Motor Size/Type 172mm x 12mm, AC
Amps 0.275 on High
RPM (High/Low) 159/74

Blade Finish



Brazilian Cherry (side 1)



Yellow Walnut (side 2)

HANGING MEASUREMENTS

Min. Fixture Drop (from ceiling)	A: 31.3cm
Min. Blade Drop (from ceiling)	B: 27.9cm
Housing (width)	C: 27.7cm
Ceiling Canopy (width)	D: 16.5cm

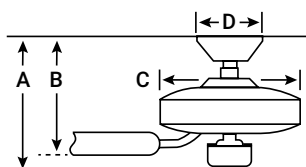

AIR PERFORMANCE

AIRFLOW Cubic ft. per minute on high	4844
POWER USAGE Watts on High (excludes lights)	65
AIRFLOW EFFICIENCY Cubic ft. per minute per Watt	74



SAVOY 52" / 132cm bladespan

The casual traditional Savoy ceiling fan is well suited for larger rooms. It is available in four different finishes to suit a wide variety of interior spaces. The Savoy features Hunter's Three-position Mounting System, Installer's Choice[®], which allows for it to be installed as either flush, standard or at an angle for sloped ceilings.



AC

52
inch

132
cm

SAVOY



Hunter

Code: HT-24520

Finish: Antique Brass

INCLUDED FEATURES

Downrods 1 x 76mm

Mounting Options Standard, Angled, Flush

Light kit Adaptable (see page 165)

FAN FEATURES

Mounting Slope/Pitch 35°

Location Rating (Dry)

Hanging Weight 7.5kg

Body Material Cold Rolled Steel

Warranty Limited Lifetime Motor

BLADE SPECS

Blades (5) included

Pitch | 12°

Material | Plywood

Blade Finish



Rosewood
(side 1)



Medium Oak
(side 2)

INCLUDED CONTROLS



PULL CHAIN

- 3 forward speeds & motor off

MOTOR FEATURES

Motor Size/Type 172mm x 15mm, AC

Amps 0.268 on High

RPM (High/Low) 183/93

HANGING MEASUREMENTS

Min. Fixture Drop (from ceiling) **A:** 36.5cm

Min. Blade Drop (from ceiling) **B:** 32cm

Housing (width) **C:** 30.1cm

Ceiling Canopy (width) **D:** 15.8cm

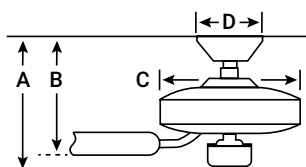

AIR PERFORMANCE

AIRFLOW
Cubic ft. per minute on high **5089**

POWER USAGE
Watts on High (excludes lights) **64**

AIRFLOW EFFICIENCY
Cubic ft. per minute per Watt **80**



Code: HT-24521

Finish: Brushed Nickel



INCLUDED FEATURES

Downrods 1 x 76mm
Mounting Options Standard, Angled, Flush
 Light kit Adaptable (see page 165)

FAN FEATURES

Mounting Slope/Pitch 35°
Location Rating (Dry)
Hanging Weight 7.5kg
Body Material Cold Rolled Steel
Warranty Limited Lifetime Motor

BLADE SPECS

Blades (5) included

Pitch | 12°

Material | Plywood

INCLUDED CONTROLS



PULL CHAIN

- 3 forward speeds & motor off

MOTOR FEATURES

Motor Size/Type 172mm x 15mm, AC
Amps 0.268 on High
RPM (High/Low) 183/93

Blade Finish



Maple
(side 1)



Cherry Walnut
(side 2)

HANGING MEASUREMENTS

Min. Fixture Drop (from ceiling)	A: 36.5cm
Min. Blade Drop (from ceiling)	B: 32cm
Housing (width)	C: 30.1cm
Ceiling Canopy (width)	D: 15.8cm

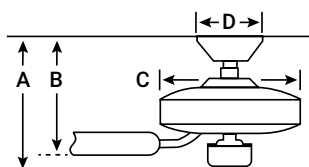

AIR PERFORMANCE

AIRFLOW Cubic ft. per minute on high	5089
POWER USAGE Watts on High (excludes lights)	64
AIRFLOW EFFICIENCY Cubic ft. per minute per Watt	80



AC

52
inch

132
cm

SAVOY



Hunter

Code: HT-24526

Finish: White

INCLUDED FEATURES

Downrods 1 x 76mm

Mounting Options Standard, Angled, Flush

Light kit Adaptable (see page 165)

FAN FEATURES

Mounting Slope/Pitch 35°

Location Rating (Dry)

Hanging Weight 7.5kg

Body Material Cold Rolled Steel

Warranty Limited Lifetime Motor

BLADE SPECS

Blades (5) included

Pitch | 12°

Material | Plywood

Blade Finish



White
(side 1)



Light Oak
(side 2)

INCLUDED CONTROLS



PULL CHAIN

- 3 forward speeds & motor off

MOTOR FEATURES

Motor Size/Type 172mm x 15mm, AC

Amps 0.268 on High

RPM (High/Low) 183/93

HANGING MEASUREMENTS

Min. Fixture Drop (from ceiling) **A:** 36.5cm

Min. Blade Drop (from ceiling) **B:** 32cm

Housing (width) **C:** 30.1cm

Ceiling Canopy (width) **D:** 15.8cm

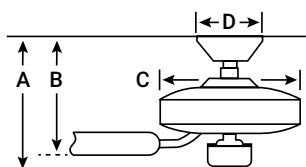

AIR PERFORMANCE

AIRFLOW
Cubic ft. per minute on high **5089**

POWER USAGE
Watts on High (excludes lights) **64**

AIRFLOW EFFICIENCY
Cubic ft. per minute per Watt **80**



SAVOY

52" / 132cm
bladespan

The casual traditional Savoy ceiling fan is well suited for larger rooms. It is available in four different finishes to suit a wide variety of interior spaces. The Savoy features Hunter's Three-position Mounting System, Installer's Choice[®], which allows for it to be installed as either flush, standard or at an angle for sloped ceilings.



AC

52
inch

132
cm

SAVOY



Hunter

Code: HT-24525

Finish: Amber Bronze

INCLUDED FEATURES

Downrods 1 x 76mm

Mounting Options Standard, Angled, Flush

Light kit Adaptable (see page 165)

FAN FEATURES

Mounting Slope/Pitch 35°

Location Rating (Dry)

Hanging Weight 7.5kg

Body Material Cold Rolled Steel

Warranty Limited Lifetime Motor

BLADE SPECS

Blades (5) included

Pitch | 12°

Material | Plywood

INCLUDED CONTROLS



PULL CHAIN

- 3 forward speeds & motor off

MOTOR FEATURES

Motor Size/Type 172mm x 15mm, AC

Amps 0.268 on High

RPM (High/Low) 183/93

Blade Finish



Distressed Cherry
(side 1)



Mahogany
(side 2)

HANGING MEASUREMENTS

Min. Fixture Drop (from ceiling) **A:** 36.5cm

Min. Blade Drop (from ceiling) **B:** 32cm

Housing (width) **C:** 30.1cm

Ceiling Canopy (width) **D:** 15.8cm

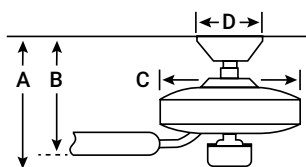

AIR PERFORMANCE

AIRFLOW
Cubic ft. per minute on high **5089**

POWER USAGE
Watts on High (excludes lights) **64**

AIRFLOW EFFICIENCY
Cubic ft. per minute per Watt **80**



INDUSTRIE II

52" / 132cm
bladespan

With soft modern styling, the Industrie II is well suited for contemporary rooms and is best used in larger spaces of up to 19m². Industrie II comes in Brushed Chrome, Graphite and White finishes, each included with reversible blades that give two options of finish to create a customisable look.

Hunter



AC

52
inch

132
cm

INDUSTRIE II



Hunter

Code: HT-24547
Finish: White

INCLUDED FEATURES

Downrods 1 x 76mm
Mounting Options Standard, Angled, Flush
Light kit Adaptable (see page 165)

FAN FEATURES

Mounting Slope/Pitch 35°
Location Rating (Dry)
Hanging Weight 7.1kg
Body Material Cold Rolled Steel
Warranty Limited Lifetime Motor

BLADE SPECS

Blades (3) included
Pitch | 15°
Material | Plywood

INCLUDED CONTROLS



WALL CONTROL

- 3 forward speeds & motor off
- includes 2 plates, square and rectangle

MOTOR FEATURES

Motor Size/Type 172mm x 15mm, AC
Amps 0.274 on High
RPM (High/Low) 157/79

Blade Finish



HANGING MEASUREMENTS

Min. Fixture Drop (from ceiling)	A: 32.2cm
Min. Blade Drop (from ceiling)	B: 36.7cm
Housing (width)	C: 18.9cm
Ceiling Canopy (width)	D: 15.7cm

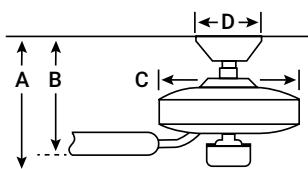

AIR PERFORMANCE	
AIRFLOW Cubic ft. per minute on high	5240
POWER USAGE Watts on High (excludes lights)	65
AIRFLOW EFFICIENCY Cubic ft. per minute per Watt	80



Code: HT-24542
Finish: Brushed Chrome



INCLUDED FEATURES

Downrods 1 x 76mm
Mounting Options Standard, Angled, Flush
Light kit Adaptable (see page 165)

FAN FEATURES

Mounting Slope/Pitch 35°
Location Rating (Dry)
Hanging Weight 7.1kg
Body Material Cold Rolled Steel
Warranty Limited Lifetime Motor

BLADE SPECS

Blades (3) included

Pitch	15°
Material	Plywood

Blade Finish

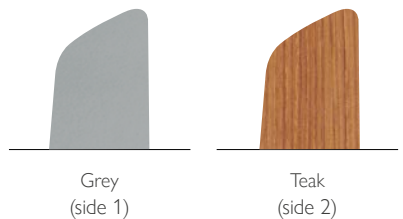

INCLUDED CONTROLS



WALL CONTROL

- 3 forward speeds & motor off
- includes 2 plates, square and rectangle

MOTOR FEATURES

Motor Size/Type 172mm x 15mm, AC
Amps 0.274 on High
RPM (High/Low) 157/79

HANGING MEASUREMENTS

Min. Fixture Drop (from ceiling)	A: 32.2cm
Min. Blade Drop (from ceiling)	B: 36.7cm
Housing (width)	C: 18.9cm
Ceiling Canopy (width)	D: 15.7cm

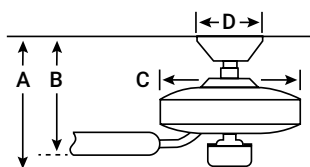

AIR PERFORMANCE

AIRFLOW Cubic ft. per minute on high	5240
POWER USAGE Watts on High (excludes lights)	65
AIRFLOW EFFICIENCY Cubic ft. per minute per Watt	80



AC

52
inch

132
cm

INDUSTRIE II



Hunter

Code: HT-24545
Finish: Graphite

INCLUDED FEATURES

Downrods 1 x 76mm
Mounting Options Standard, Angled, Flush
Light kit Adaptable (see page 165)

FAN FEATURES

Mounting Slope/Pitch 35°
Location Rating (Dry)
Hanging Weight 7.1kg
Body Material Cold Rolled Steel
Warranty Limited Lifetime Motor

BLADE SPECS

Blades (3) included
Pitch 15°
Material Plywood

INCLUDED CONTROLS



WALL CONTROL

- 3 forward speeds & motor off
- includes 2 plates, square and rectangle

MOTOR FEATURES

Motor Size/Type 172mm x 15mm, AC
Amps 0.274 on High
RPM (High/Low) 157/79

Blade Finish



Graphite
(side 1)



Chestnut
(side 2)

HANGING MEASUREMENTS

Min. Fixture Drop (from ceiling)	A: 32.2cm
Min. Blade Drop (from ceiling)	B: 36.7cm
Housing (width)	C: 18.9cm
Ceiling Canopy (width)	D: 15.7cm

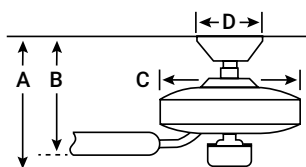

AIR PERFORMANCE

AIRFLOW Cubic ft. per minute on high	5240
POWER USAGE Watts on High (excludes lights)	65
AIRFLOW EFFICIENCY Cubic ft. per minute per Watt	80



PROTOS

52" / 132cm
bladespan

The Protos is perfect for any room in your home or office. This industrial-design fan comes with reversible blades so you can choose a soft wood tone for a gentle appearance or a metallic tone for a consistent, masculine look. The clean lines and exposed motor of this superior performing fan form a no-frills presence creating the perfect accent for your minimalist design style.





Code: HT-50623
Finish: Fresh White



INCLUDED FEATURES

Downrods 1 x 127mm & 1 x 51mm
Mounting Options Standard, Angled, Flush

FAN FEATURES

Mounting Slope/Pitch 35°
Location Rating (Humid)
Hanging Weight 7.4kg
Body Material Cold Rolled Steel
Warranty Limited Lifetime Motor

BLADE SPECS

Blades (3) included

Pitch	13°
Material	Plywood

INCLUDED CONTROLS



WALL CONTROL

- 3 forward speeds & motor off
- includes 2 plates, square and rectangle

MOTOR FEATURES

Motor Size/Type 172mm x 20mm, AC
Amps 0.27 on High
RPM (High/Low) 195/103

Blade Finish



Fresh White
(side 1)



Light Stripe
(side 2)

HANGING MEASUREMENTS

Min. Fixture Drop (from ceiling)	A: 33cm
Min. Blade Drop (from ceiling)	B: 27.5cm
Housing (width)	C: 15.6cm
Ceiling Canopy (width)	D: 16.5cm

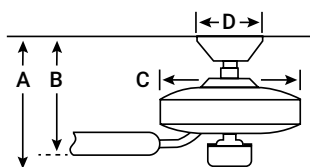

AIR PERFORMANCE

AIRFLOW Cubic ft. per minute on high	4542
POWER USAGE Watts on High (excludes lights)	61
AIRFLOW EFFICIENCY Cubic ft. per minute per Watt	74



AC

52
inch

132
cm

PROTOS



Hunter

Code: HT-50624
Finish: Matt Black

INCLUDED FEATURES

Downrods 1 x 127mm & 1 x 51mm
Mounting Options Standard, Angled, Flush

FAN FEATURES

Mounting Slope/Pitch 35°
Location Rating (Humid)
Hanging Weight 7.4kg
Body Material Cold Rolled Steel
Warranty Limited Lifetime Motor

BLADE SPECS

Blades (3) included

Pitch	13°
Material	Plywood

INCLUDED CONTROLS



WALL CONTROL

- 3 forward speeds & motor off
- includes 2 plates, square and rectangle

MOTOR FEATURES

Motor Size/Type 172mm x 20mm, AC
Amps 0.27 on High
RPM (High/Low) 195/103

Blade Finish



Matte Black
(side 1)



Grey Walnut Stripe
(side 2)

HANGING MEASUREMENTS

Min. Fixture Drop (from ceiling)	A: 33cm
Min. Blade Drop (from ceiling)	B: 27.5cm
Housing (width)	C: 15.6cm
Ceiling Canopy (width)	D: 16.5cm

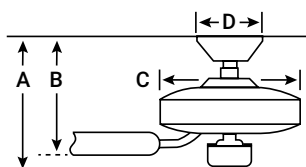

AIR PERFORMANCE

AIRFLOW Cubic ft. per minute on high	4542
POWER USAGE Watts on High (excludes lights)	61
AIRFLOW EFFICIENCY Cubic ft. per minute per Watt	74



LOKI

52" / 132cm
bladespan

Brighten up small rooms with the Loki ceiling fan. Available in three finishes with reversible blade finishes, you can customise the look of this small ceiling fan in your guest bedrooms, home offices, nurseries, and family rooms.



AC

52
inch

132
cm

LOKI



Hunter

Code: HT-50425

Finish: Matte Black

INCLUDED FEATURES

- Downrods** 1 x 102mm & 1 x 51mm
- Mounting Options** Standard, Angled, Flush
- Light Type** 2 x 28W E27, Dimmable Bulbs Recommended (Not Included)
- Light Glass** Painted Cased White

FAN FEATURES

- Mounting Slope/Pitch** 35°
- Location Rating** (Dry)
- Hanging Weight** 10.4kg
- Body Material** Cold Rolled Steel
- Warranty** Limited Lifetime Motor

BLADE SPECS

- Blades** (4) included
- Pitch | 13°
- Material | Composite

INCLUDED CONTROLS



REMOTE CONTROL

- 3 forward speeds & motor off
- lights on/off with full-range dimming

MOTOR FEATURES

- Motor Size/Type** 172mm x 20mm, AC
- RPM (High)** 175

Blade Finish



Light Greyed Oak
(side 1)



Flat Matte Black
(side 2)

HANGING MEASUREMENTS

Min. Fixture Drop (from ceiling)	A: 42.8cm
Min. Blade Drop (from ceiling)	B: 29.3cm
Housing (width)	C: 21.1cm
Ceiling Canopy (width)	D: 16.5cm

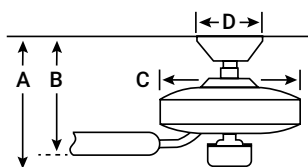

AIR PERFORMANCE

AIRFLOW Cubic ft. per minute on high	5290
POWER USAGE Watts on High (excludes lights)	63
AIRFLOW EFFICIENCY Cubic ft. per minute per Watt	84



Code: HT-50424

Finish: Brushed Nickel



INCLUDED FEATURES

Downrods 1 x 102mm & 1 x 51mm

Mounting Options Standard, Angled, Flush

Light Type 2 x 28W E27, Dimmable Bulbs Recommended (Not Included)

Light Glass Painted Cased White

FAN FEATURES

Mounting Slope/Pitch 35°

Location Rating (Dry)

Hanging Weight 10.4kg

Body Material Cold Rolled Steel

Warranty Limited Lifetime Motor

BLADE SPECS

Blades (4) included

Pitch | 13°

Material | Composite

INCLUDED CONTROLS



REMOTE CONTROL

- 3 forward speeds & motor off
- lights on/off with full-range dimming

MOTOR FEATURES

Motor Size/Type 172mm x 20mm, AC

RPM (High) 175

Blade Finish



Light Greyed Oak (side 1)



Natural Wood (side 2)

HANGING MEASUREMENTS

Min. Fixture Drop (from ceiling) **A:** 42.8cm

Min. Blade Drop (from ceiling) **B:** 29.3cm

Housing (width) **C:** 21.1cm

Ceiling Canopy (width) **D:** 16.5cm

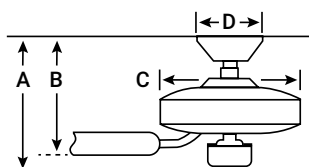

AIR PERFORMANCE

AIRFLOW
Cubic ft. per minute on high **5290**

POWER USAGE
Watts on High (excludes lights) **63**

AIRFLOW EFFICIENCY
Cubic ft. per minute per Watt **84**



AC

52
inch

132
cm

LOKI



Code: HT-50423
Finish: Fresh White

INCLUDED FEATURES

- Downrods** 1 x 102mm & 1 x 51mm
- Mounting Options** Standard, Angled, Flush
- Light Type** 2 x 28W E27, Dimmable Bulbs Recommended (Not Included)
- Light Glass** Painted Cased White

FAN FEATURES

- Mounting Slope/Pitch** 35°
- Location Rating** (Dry)
- Hanging Weight** 10.4kg
- Body Material** Cold Rolled Steel
- Warranty** Limited Lifetime Motor

BLADE SPECS

Blades (4) included	
Pitch	13°
Material	Composite

INCLUDED CONTROLS



REMOTE CONTROL

- 3 forward speeds & motor off
- lights on/off with full-range dimming

MOTOR FEATURES

- Motor Size/Type** 172mm x 20mm, AC
- RPM (High)** 175

Blade Finish

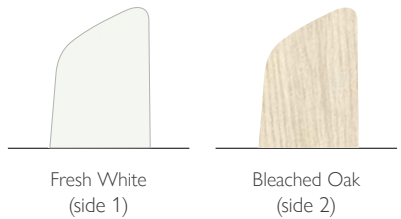

HANGING MEASUREMENTS

Min. Fixture Drop (from ceiling)	A: 42.8cm
Min. Blade Drop (from ceiling)	B: 29.3cm
Housing (width)	C: 21.1cm
Ceiling Canopy (width)	D: 16.5cm

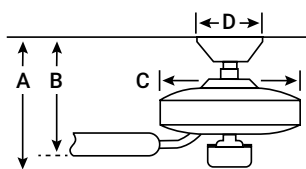

AIR PERFORMANCE	
AIRFLOW Cubic ft. per minute on high	5290
POWER USAGE Watts on High (excludes lights)	63
AIRFLOW EFFICIENCY Cubic ft. per minute per Watt	84



CABO FRIO

52" / 132cm
bladespan

The Cabo Frio ceiling fan has three blades with a distinct curved shape on one side that is evocative of plane propellers. Ideal for anyone with an eye for modern design, Cabo Frio is available in three finishes; Resort White, Antique Pewter and New Bronze.

Hunter



AC

52
inch

132
cm

CABO FRIO



Hunter

Code: HT-50638

Finish: Antique Pewter

INCLUDED FEATURES

Downrods 1 x 102mm

Mounting Options Standard, Angled

FAN FEATURES

Mounting Slope/Pitch 35°

Location Rating (Humid)

Hanging Weight 7.7kg

Body Material Cold Rolled Steel

Warranty Limited Lifetime Motor

BLADE SPECS

Blades (3) included

Pitch | variable°

Material | Plastic

Blade Finish



Antique Black
(side 1)



Antique Black
(side 2)

INCLUDED CONTROLS



WALL CONTROL

- 3 forward speeds & motor off
- includes 2 plates, square and rectangle

MOTOR FEATURES

Motor Size/Type 172mm x 20mm, AC

Amps 0.258 on High

RPM (High/Low) 161/88

HANGING MEASUREMENTS

Min. Fixture Drop (from ceiling) **A:** 33.4cm

Min. Blade Drop (from ceiling) **B:** 27.9cm

Housing (width) **C:** 17.4cm

Ceiling Canopy (width) **D:** 15.8cm

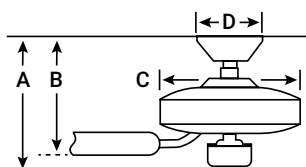

AIR PERFORMANCE

AIRFLOW
Cubic ft. per minute on high **5180**

POWER USAGE
Watts on High (excludes lights) **72**

AIRFLOW EFFICIENCY
Cubic ft. per minute per Watt **83**



Code: HT-50635
Finish: New Bronze



INCLUDED FEATURES

Downrods 1 x 102mm
Mounting Options Standard, Angled

FAN FEATURES

Mounting Slope/Pitch 35°
Location Rating (Humid)
Hanging Weight 7.7kg
Body Material Cold Rolled Steel
Warranty Limited Lifetime Motor

BLADE SPECS

Blades (3) included

Pitch	variable°
Material	Plastic

INCLUDED CONTROLS



WALL CONTROL

- 3 forward speeds & motor off
- includes 2 plates, square and rectangle

MOTOR FEATURES

Motor Size/Type 172mm x 20mm, AC
Amps 0.258 on High
RPM (High/Low) 161/88

Blade Finish

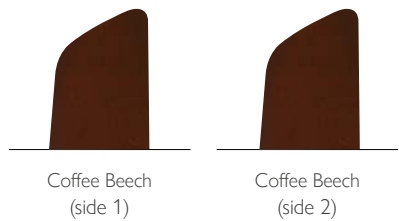

HANGING MEASUREMENTS

Min. Fixture Drop (from ceiling)	A: 33.4cm
Min. Blade Drop (from ceiling)	B: 27.9cm
Housing (width)	C: 17.4cm
Ceiling Canopy (width)	D: 15.8cm

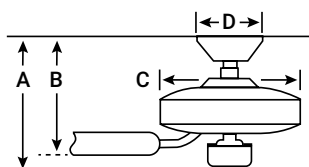

AIR PERFORMANCE

AIRFLOW Cubic ft. per minute on high	5180
POWER USAGE Watts on High (excludes lights)	72
AIRFLOW EFFICIENCY Cubic ft. per minute per Watt	83



AC

52
inch

132
cm

CABO FRIO



Hunter

Code: HT-50634

Finish: Resort White

INCLUDED FEATURES

Downrods 1 x 102mm

Mounting Options Standard, Angled

FAN FEATURES

Mounting Slope/Pitch 35°

Location Rating (Humid)

Hanging Weight 7.7kg

Body Material Cold Rolled Steel

Warranty Limited Lifetime Motor

BLADE SPECS

Blades (3) included

Pitch | variable°

Material | Plastic

Blade Finish



White
(side 1)



White
(side 2)

INCLUDED CONTROLS



WALL CONTROL

- 3 forward speeds & motor off
- includes 2 plates, square and rectangle

MOTOR FEATURES

Motor Size/Type 172mm x 20mm, AC

Amps 0.258 on High

RPM (High/Low) 161/88

HANGING MEASUREMENTS

Min. Fixture Drop (from ceiling) **A:** 33.4cm

Min. Blade Drop (from ceiling) **B:** 27.9cm

Housing (width) **C:** 17.4cm

Ceiling Canopy (width) **D:** 15.8cm

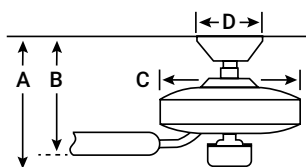

AIR PERFORMANCE

AIRFLOW
Cubic ft. per minute on high **5180**

POWER USAGE
Watts on High (excludes lights) **72**

AIRFLOW EFFICIENCY
Cubic ft. per minute per Watt **83**



STILE

46" / 117cm
bladespan

From the ceiling all the way down to the glass, the Stile maintains a consistent curve resembling a refreshing drop of water. This fan is an excellent accent to your contemporary décor. It shines enough light and moves enough air to be the ideal fit for small or standard-sized rooms.





Code: HT-50640
Finish: Matte Silver

INCLUDED FEATURES

Downrods 1 x 102mm & 1 x 51mm
Mounting Options Standard, Angled, Flush
Light Type 2 x 14W E27, Dimmable Bulbs Recommended (Not Included)
Light Glass Painted Cased White

INCLUDED CONTROLS



REMOTE CONTROL

- 3 forward speeds & motor off
- lights on/off with full-range dimming

FAN FEATURES

Mounting Slope/Pitch 35°
Location Rating (Dry)
Hanging Weight 9.2kg
Body Material Cold Rolled Steel
Warranty Limited Lifetime Motor

MOTOR FEATURES

Motor Size/Type 153mm x 20mm, AC
RPM (High) 196

BLADE SPECS

Blades (5) included

Pitch	13°
Material	Composite

Blade Finish



Light Greyed Oak (side 1)



Greyed Walnut (side 2)

HANGING MEASUREMENTS

Min. Fixture Drop (from ceiling)	A: 43.4cm
Min. Blade Drop (from ceiling)	B: 27.7cm
Housing (width)	C: 19.6cm
Ceiling Canopy (width)	D: 16.5cm

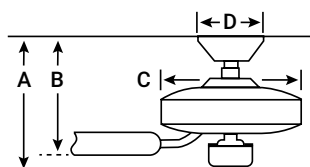

AIR PERFORMANCE

AIRFLOW Cubic ft. per minute on high	3773
POWER USAGE Watts on High (excludes lights)	60
AIRFLOW EFFICIENCY Cubic ft. per minute per Watt	63



AC

46
inch

117
cm

STILE



Code: HT-50641

Finish: Premier Bronze

INCLUDED FEATURES

- Downrods** 1 x 102mm & 1 x 51mm
- Mounting Options** Standard, Angled, Flush
- Light Type** 2 x 14W E27, Dimmable Bulbs Recommended (Not Included)
- Light Glass** Painted Cased White

FAN FEATURES

- Mounting Slope/Pitch** 35°
- Location Rating** (Dry)
- Hanging Weight** 9.2kg
- Body Material** Cold Rolled Steel
- Warranty** Limited Lifetime Motor

BLADE SPECS

- Blades** (5) included
- Pitch** 13°
- Material** Composite

INCLUDED CONTROLS



REMOTE CONTROL

- 3 forward speeds & motor off
- lights on/off with full-range dimming

MOTOR FEATURES

- Motor Size/Type** 153mm x 20mm, AC
- RPM (High)** 196

Blade Finish

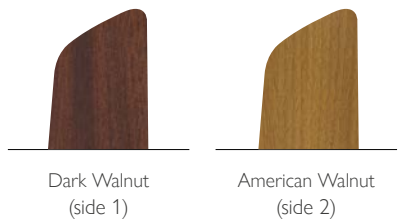

HANGING MEASUREMENTS

- Min. Fixture Drop** (from ceiling) **A:** 43.4cm
- Min. Blade Drop** (from ceiling) **B:** 27.7cm
- Housing** (width) **C:** 19.6cm
- Ceiling Canopy** (width) **D:** 16.5cm

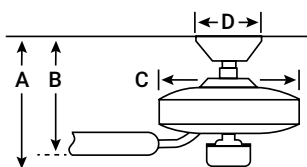

AIR PERFORMANCE	
AIRFLOW Cubic ft. per minute on high	3773
POWER USAGE Watts on High (excludes lights)	60
AIRFLOW EFFICIENCY Cubic ft. per minute per Watt	63



ARCOT 46" / 117cm bladespan

A contemporary fan with sleek finishes, the Arcot will fit flawlessly in your home's modern, small living space. We recommend using dimmable, energy-efficient LED bulbs to give you total control over your lighting so you can create the perfect ambiance.



AC

46
inch

117
cm

ARCOT



Code: HT-50647
Finish: Fresh White

INCLUDED FEATURES

- Downrods** 1 x 102mm & 1 x 51mm
- Mounting Options** Standard, Angled, Flush
- Light Type** 2 x 14W E27, Dimmable Bulbs Recommended (Not Included)
- Light Glass** Painted Cased White

FAN FEATURES

- Mounting Slope/Pitch** 35°
- Location Rating** (Dry)
- Hanging Weight** 10.3kg
- Body Material** Cold Rolled Steel
- Warranty** Limited Lifetime Motor

BLADE SPECS

- Blades** (5) included
- Pitch | 13°
- Material | Composite

INCLUDED CONTROLS



REMOTE CONTROL

- 3 forward speeds & motor off
- lights on/off with full-range dimming

MOTOR FEATURES

- Motor Size/Type** 172mm x 20mm, AC
- RPM (High)** 197

Blade Finish

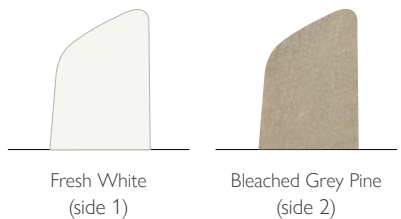

HANGING MEASUREMENTS

- Min. Fixture Drop** (from ceiling) **A:** 39.8cm
- Min. Blade Drop** (from ceiling) **B:** 28cm
- Housing** (width) **C:** 19.8cm
- Ceiling Canopy** (width) **D:** 16.5cm

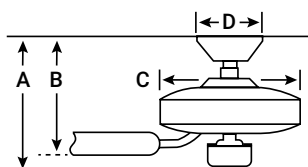

AIR PERFORMANCE	
AIRFLOW Cubic ft. per minute on high	4132
POWER USAGE Watts on High (excludes lights)	62
AIRFLOW EFFICIENCY Cubic ft. per minute per Watt	66



ARCOT 46" / 117cm bladespan

A contemporary fan with sleek finishes, the Arcot will fit flawlessly in your home's modern, small living space. We recommend using dimmable, energy-efficient LED bulbs to give you total control over your lighting so you can create the perfect ambiance.

Hunter



AC

46
inch

117
cm

ARCOT



Hunter

Code: HT-50646

Finish: Brushed Nickel

INCLUDED FEATURES

- Downrods** 1 x 102mm & 1 x 51mm
- Mounting Options** Standard, Angled, Flush
- Light Type** 2 x 14W E27, Dimmable Bulbs Recommended (Not Included)
- Light Glass** Painted Cased White

FAN FEATURES

- Mounting Slope/Pitch** 35°
- Location Rating** (Dry)
- Hanging Weight** 10.3kg
- Body Material** Cold Rolled Steel
- Warranty** Limited Lifetime Motor

BLADE SPECS

- Blades** (5) included
- Pitch** 13°
- Material** Composite

INCLUDED CONTROLS



REMOTE CONTROL

- 3 forward speeds & motor off
- lights on/off with full-range dimming

MOTOR FEATURES

- Motor Size/Type** 172mm x 20mm, AC
- RPM (High)** 197

Blade Finish



HANGING MEASUREMENTS

- Min. Fixture Drop** (from ceiling) **A:** 39.8cm
- Min. Blade Drop** (from ceiling) **B:** 28cm
- Housing** (width) **C:** 19.8cm
- Ceiling Canopy** (width) **D:** 16.5cm

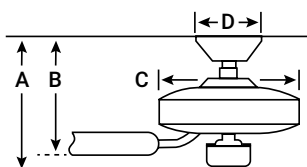

AIR PERFORMANCE	
AIRFLOW Cubic ft. per minute on high	4132
POWER USAGE Watts on High (excludes lights)	62
AIRFLOW EFFICIENCY Cubic ft. per minute per Watt	66



LOW PROFILE III

44" / 112cm
or 52" / 132cm
bladespan

The Hunter Low Profile® III traditional ceiling fan is designed with housing specially crafted to fit flush to the ceiling making it ideal for use in your small rooms with low ceilings. This low-profile ceiling fan is powered by a three-speed WhisperWind® motor to deliver ultra-powerful and whisper-quiet performance making it the perfect complement for your casual living rooms and bedrooms.



AC

52
inch

132
cm

44
inch

112
cm

LOW PROFILE III



Hunter

Code: HT-24377

Finish: White

INCLUDED FEATURES

Downrods Not Available
Mounting Options Flush
Light kit Adaptable (see page 165)

FAN FEATURES

Location Rating (Dry)
Hanging Weight 8kg
Body Material Cold Rolled Steel
Warranty Limited Lifetime Motor

BLADE SPECS

Blades (2 x 5) both sizes included

Pitch	12°
Material	Plywood

INCLUDED CONTROLS



PULL CHAIN

- 3 forward speeds & motor off

MOTOR FEATURES

Motor Size/Type 172mm x 15mm, AC
Amps 0.269 on High
RPM (High/Low) 182/96

Blade Finish



HANGING MEASUREMENTS

Min. Fixture Drop (from ceiling)	A: 24.6cm
Min. Blade Drop (from ceiling)	B: 19.8cm
Housing (width)	C: 31.7cm
Ceiling Canopy (width)	D: 31.8cm

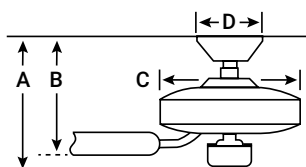

AIR PERFORMANCE

AIRFLOW Cubic ft. per minute on high	4247
POWER USAGE Watts on High (excludes lights)	66
AIRFLOW EFFICIENCY Cubic ft. per minute per Watt	65



SEVILLE II 44" / 112cm bladespan

The Seville II ceiling fan has a simplified casual style well suited for more traditionally decorated rooms. With a 112cm blade span, it will complement smaller rooms of roughly 10m². It is available in three finishes; Antique Brass, New Bronze and Snow White. Each ceiling fan features reversible blades with a choice of two finishes.



AC

44
inch

112
cm

SEVILLE II



Hunter

Code: HT-24037
Finish: Snow White

INCLUDED FEATURES

Downrods 1 x 76mm
Mounting Options Standard, Angled, Flush
Light kit Adaptable (see page 165)

FAN FEATURES

Mounting Slope/Pitch 35°
Location Rating (Dry)
Hanging Weight 7.7kg
Body Material Cold Rolled Steel
Warranty Limited Lifetime Motor

BLADE SPECS

Blades (5) included
Pitch | 12°
Material | Plywood

INCLUDED CONTROLS



PULL CHAIN

- 3 forward speeds & motor off

MOTOR FEATURES

Motor Size/Type 172mm x 15mm, AC
Amps 0.26 on High
RPM (High/Low) 226/123

Blade Finish



White (side 1)



Light Oak (side 2)

HANGING MEASUREMENTS

Min. Fixture Drop (from ceiling)	A: 34.5cm
Min. Blade Drop (from ceiling)	B: 31cm
Housing (width)	C: 27.1cm
Ceiling Canopy (width)	D: 15.8cm

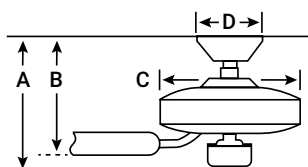

AIR PERFORMANCE

AIRFLOW Cubic ft. per minute on high	4574
POWER USAGE Watts on High (excludes lights)	63
AIRFLOW EFFICIENCY Cubic ft. per minute per Watt	72



Code: HT-24034
Finish: Antique Brass



INCLUDED FEATURES

Downrods 1 x 76mm
Mounting Options Standard, Angled, Flush
Light kit Adaptable (see page 165)

FAN FEATURES

Mounting Slope/Pitch 35°
Location Rating (Dry)
Hanging Weight 7.7kg
Body Material Cold Rolled Steel
Warranty Limited Lifetime Motor

BLADE SPECS

Blades (5) included

Pitch	12°
Material	Plywood

Blade Finish

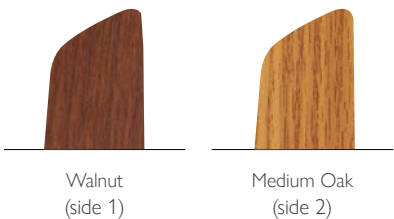

INCLUDED CONTROLS



PULL CHAIN

- 3 forward speeds & motor off

MOTOR FEATURES

Motor Size/Type 172mm x 15mm, AC
Amps 0.26 on High
RPM (High/Low) 226/123

HANGING MEASUREMENTS

Min. Fixture Drop (from ceiling)	A: 34.5cm
Min. Blade Drop (from ceiling)	B: 31cm
Housing (width)	C: 27.1cm
Ceiling Canopy (width)	D: 15.8cm

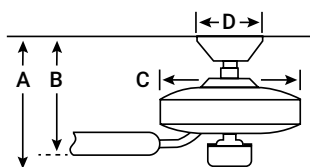

AIR PERFORMANCE

AIRFLOW Cubic ft. per minute on high	4574
POWER USAGE Watts on High (excludes lights)	63
AIRFLOW EFFICIENCY Cubic ft. per minute per Watt	72



AC

44
inch

112
cm

SEVILLE II



Hunter

Code: HT-24039

Finish: New Bronze

INCLUDED FEATURES

Downrods 1 x 76mm
Mounting Options Standard, Angled, Flush
Light kit Adaptable (see page 165)

FAN FEATURES

Mounting Slope/Pitch 35°
Location Rating (Dry)
Hanging Weight 7.7kg
Body Material Cold Rolled Steel
Warranty Limited Lifetime Motor

BLADE SPECS

Blades (5) included
Pitch | 12°
Material | Plywood

INCLUDED CONTROLS



PULL CHAIN

- 3 forward speeds & motor off

MOTOR FEATURES

Motor Size/Type 172mm x 15mm, AC
Amps 0.26 on High
RPM (High/Low) 226/123

Blade Finish



Dark Cherry
(side 1)



Medium Oak
(side 2)

HANGING MEASUREMENTS

Min. Fixture Drop (from ceiling)	A: 34.5cm
Min. Blade Drop (from ceiling)	B: 31cm
Housing (width)	C: 27.1cm
Ceiling Canopy (width)	D: 15.8cm

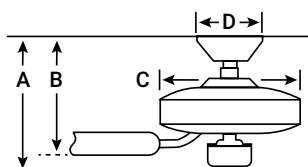

AIR PERFORMANCE

AIRFLOW Cubic ft. per minute on high	4574
POWER USAGE Watts on High (excludes lights)	63
AIRFLOW EFFICIENCY Cubic ft. per minute per Watt	72



DANTE

44" / 112cm
bladespan

A contemporary fan with mass appeal, the Dante will fit flawlessly in your home's modern interior design. The beautiful, clean finish options work together with the high contrast of angles throughout the design to create a look that will keep your space looking current and inspired. The 112cm blade span is ideal for small rooms.



CREAT



OFFICE





Code: HT-50628

Finish: Brushed Nickel



INCLUDED FEATURES

- Downrods** 1 x 64mm
- Mounting Options** Standard, Angled, Flush
- Light Type** 2 x 14W E27, Dimmable Bulbs Recommended (Not Included)
- Light Glass** Painted Cased White

FAN FEATURES

- Mounting Slope/Pitch** 35°
- Location Rating** (Dry)
- Hanging Weight** 9.4kg
- Body Material** Cold Rolled Steel
- Warranty** Limited Lifetime Motor

BLADE SPECS

Blades (4) included

Pitch	13°
Material	MDF

INCLUDED CONTROLS



REMOTE CONTROL

- 3 forward speeds & motor off
- lights on/off with full-range dimming

MOTOR FEATURES

- Motor Size/Type** 172mm x 20mm, AC
- Amps** 0.253 on High
- RPM (High/Low)** 253/134

Blade Finish



Black Oak
(side 1)



Chocolate Oak
Grain
(side 2)

HANGING MEASUREMENTS

Min. Fixture Drop (from ceiling)	A: 34.3cm
Min. Blade Drop (from ceiling)	B: 23.3cm
Housing (width)	C: 25.6cm
Ceiling Canopy (width)	D: 16.5cm

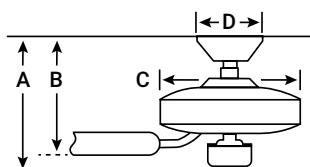

AIR PERFORMANCE

AIRFLOW Cubic ft. per minute on high	4594
POWER USAGE Watts on High (excludes lights)	60
AIRFLOW EFFICIENCY Cubic ft. per minute per Watt	77



AC

44
inch

112
cm

DANTE



Code: HT-50629
Finish: Fresh White

INCLUDED FEATURES

- Downrods** 1 x 64mm
- Mounting Options** Standard, Angled, Flush
- Light Type** 2 x 14W E27, Dimmable Bulbs Recommended (Not Included)
- Light Glass** Painted Cased White

FAN FEATURES

- Mounting Slope/Pitch** 35°
- Location Rating** (Dry)
- Hanging Weight** 9.4kg
- Body Material** Cold Rolled Steel
- Warranty** Limited Lifetime Motor

BLADE SPECS

Blades (4) included

Pitch	13°
Material	MDF

INCLUDED CONTROLS



REMOTE CONTROL

- 3 forward speeds & motor off
- lights on/off with full-range dimming

MOTOR FEATURES

- Motor Size/Type** 172mm x 20mm, AC
- Amps** 0.253 on High
- RPM (High/Low)** 253/134

Blade Finish



HANGING MEASUREMENTS

Min. Fixture Drop (from ceiling)	A: 34.3cm
Min. Blade Drop (from ceiling)	B: 23.3cm
Housing (width)	C: 25.6cm
Ceiling Canopy (width)	D: 16.5cm

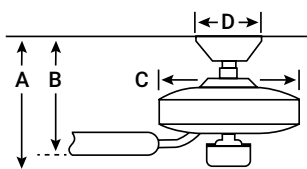

AIR PERFORMANCE	
AIRFLOW Cubic ft. per minute on high	4594
POWER USAGE Watts on High (excludes lights)	60
AIRFLOW EFFICIENCY Cubic ft. per minute per Watt	77



BAYPORT 42" / 107cm bladespan

With a 107cm blade span, the Bayport is a more petite take on traditional American ceiling fans, making it well suited for smaller rooms. It is available in Antique Brass or White finishes, each featuring reversible blades with a choice of two finishes either side.





Code: HT-24174
Finish: Antique Brass



INCLUDED FEATURES

Downrods 1 x 76mm
Mounting Options Standard, Angled, Flush
Light kit Adaptable (see page 165)

FAN FEATURES

Mounting Slope/Pitch 35°
Location Rating (Dry)
Hanging Weight 6.5kg
Body Material Cold Rolled Steel
Warranty Limited Lifetime Motor

BLADE SPECS

Blades (4) included

Pitch	13°
Material	MDF

INCLUDED CONTROLS



PULL CHAIN
• 3 forward speeds & motor off

MOTOR FEATURES

Motor Size/Type 172mm x 12mm, AC
Amps 0.254 on High
RPM (High/Low) 240/123

Blade Finish



Rosewood
(side 1)



Medium Oak
(side 2)

HANGING MEASUREMENTS

Min. Fixture Drop (from ceiling)	A: 32.7cm
Min. Blade Drop (from ceiling)	B: 29.1cm
Housing (width)	C: 24.1cm
Ceiling Canopy (width)	D: 15.8cm

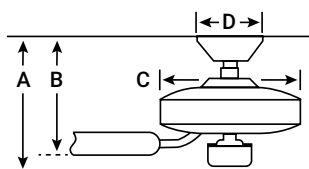

AIR PERFORMANCE

AIRFLOW Cubic ft. per minute on high	4137
POWER USAGE Watts on High (excludes lights)	62
AIRFLOW EFFICIENCY Cubic ft. per minute per Watt	66



AC

42
inch

107
cm

BAYPORT



Code: HT-24170
Finish: White

INCLUDED FEATURES

Downrods 1 x 76mm
Mounting Options Standard, Angled, Flush
Light kit Adaptable (see page 165)

FAN FEATURES

Mounting Slope/Pitch 35°
Location Rating (Dry)
Hanging Weight 6.5kg
Body Material Cold Rolled Steel
Warranty Limited Lifetime Motor

BLADE SPECS

Blades (4) included
Pitch 13°
Material MDF

INCLUDED CONTROLS



PULL CHAIN

- 3 forward speeds & motor off

MOTOR FEATURES

Motor Size/Type 172mm x 12mm, AC
Amps 0.254 on High
RPM (High/Low) 240/123

Blade Finish

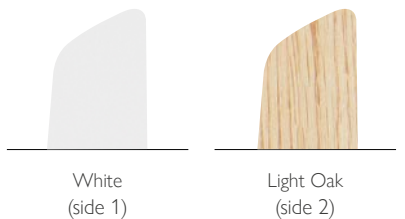

HANGING MEASUREMENTS

Min. Fixture Drop (from ceiling)	A: 32.7cm
Min. Blade Drop (from ceiling)	B: 29.1cm
Housing (width)	C: 24.1cm
Ceiling Canopy (width)	D: 15.8cm

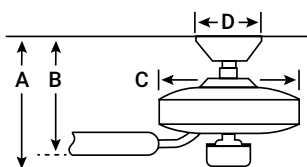

AIR PERFORMANCE	
AIRFLOW Cubic ft. per minute on high	4137
POWER USAGE Watts on High (excludes lights)	62
AIRFLOW EFFICIENCY Cubic ft. per minute per Watt	66



FINLEY

36" / 91cm
bladespan

The Scandinavian-style lighting complemented by a mid-century colour palette, along with the rounded edges throughout gives the Finley a soft, modern look. With a 91cm blade span, these small ceiling fans with lights are perfect for spaces like home offices and hallways. But don't let the size fool you – the Finley is quite powerful when it comes to airflow and keeping you cool.

Hunter



AC

36
inch

91
cm

FINLEY



Hunter

Code: HT-50644
Finish: Fresh White

INCLUDED FEATURES

- Downrods** 1 x 102mm & 1 x 51mm
- Mounting Options** Standard, Angled, Flush
- Light Type** 2 x 14W E27, Dimmable Bulbs Recommended (Not Included)
- Light Glass** Painted Cased White

FAN FEATURES

- Mounting Slope/Pitch** 35°
- Location Rating** (Dry)
- Hanging Weight** 8.5kg
- Body Material** Cold Rolled Steel
- Warranty** Limited Lifetime Motor

BLADE SPECS

- Blades** (3) included
- Pitch | 15°
- Material | Composite

INCLUDED CONTROLS



REMOTE CONTROL

- 3 forward speeds & motor off
- lights on/off with full-range dimming

MOTOR FEATURES

- Motor Size/Type** 153mm x 20mm, AC
- RPM (High)** 280

Blade Finish



HANGING MEASUREMENTS

- Min. Fixture Drop** (from ceiling) **A:** 40.6cm
- Min. Blade Drop** (from ceiling) **B:** 28.1cm
- Housing** (width) **C:** 21.1cm
- Ceiling Canopy** (width) **D:** 16.5cm

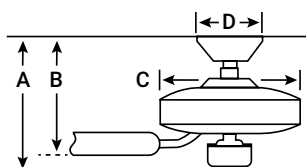

AIR PERFORMANCE

AIRFLOW Cubic ft. per minute on high	2859
POWER USAGE Watts on High (excludes lights)	50
AIRFLOW EFFICIENCY Cubic ft. per minute per Watt	57



FINLEY

36" / 91cm
bladespan

The Scandinavian-style lighting complemented by a mid-century colour palette, along with the rounded edges throughout gives the Finley a soft, modern look. With a 91cm blade span, these small ceiling fans with lights are perfect for spaces like home offices and hallways. But don't let the size fool you – the Finley is quite powerful when it comes to airflow and keeping you cool.

Hunter



AC

36
inch

91
cm

FINLEY



Hunter

Code: HT-50643

Finish: Brushed Nickel

INCLUDED FEATURES

- Downrods** 1 x 102mm & 1 x 51mm
- Mounting Options** Standard, Angled, Flush
- Light Type** 2 x 14W E27, Dimmable Bulbs Recommended (Not Included)
- Light Glass** Painted Cased White

FAN FEATURES

- Mounting Slope/Pitch** 35°
- Location Rating** (Dry)
- Hanging Weight** 8.5kg
- Body Material** Cold Rolled Steel
- Warranty** Limited Lifetime Motor

BLADE SPECS

- Blades** (3) included
- Pitch | 15°
- Material | Composite

INCLUDED CONTROLS



REMOTE CONTROL

- 3 forward speeds & motor off
- lights on/off with full-range dimming

MOTOR FEATURES

- Motor Size/Type** 153mm x 20mm, AC
- RPM (High)** 280

Blade Finish



American Walnut
(side 1)



Natural Wood
(side 2)

HANGING MEASUREMENTS

Min. Fixture Drop (from ceiling)	A: 40.6cm
Min. Blade Drop (from ceiling)	B: 28.1cm
Housing (width)	C: 21.1cm
Ceiling Canopy (width)	D: 16.5cm

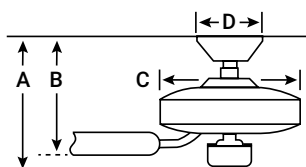

AIR PERFORMANCE

AIRFLOW Cubic ft. per minute on high	2859
POWER USAGE Watts on High (excludes lights)	50
AIRFLOW EFFICIENCY Cubic ft. per minute per Watt	57



CANFIELD

30" / 76cm
bladespan

The petite Canfield ceiling fan has transitional appeal, partnering a traditional shape with a modern Brushed Nickel housing. The UV coated blades offer a Walnut or Cherry finish to suit a variety of small spaces in the home. Canfield can be used in rooms with large openings to the outdoors, where humidity will likely affect this area.



IP20

AC

30
inch

76
cm

CANFIELD



KICHLER

Code: KLF-CANFIELD-30-BN

Finish: Brushed Nickel

INCLUDED FEATURES

Downrods 1 x 152mm

Mounting Options Standard, Angled, Flush

FAN FEATURES

Mounting Slope/Pitch 30°

Location Rating IP20 (Humid)

Hanging Weight 6.7kg

Body Material Steel

Warranty Limited Lifetime

BLADE SPECS

Blades (5) included

Pitch 24°

Material UV Coated Wood

INCLUDED CONTROLS

PULL CHAIN

- 3 Speeds
- 3 Forward & Reverse
- Manual Reverse



MOTOR FEATURES

Motor Size/Type 153mm x 17mm, AC

Amps 0.22 on High

RPM (High/Low) 264/133

Blade Finish



Walnut
(side 1)



Cherry
(side 2)

HANGING MEASUREMENTS

Min. Fixture Drop (from ceiling) **A:** 38cm

Min. Blade Drop (from ceiling) **B:** 32cm

Housing (width) **C:** 25cm

Ceiling Canopy (width) **D:** 15cm

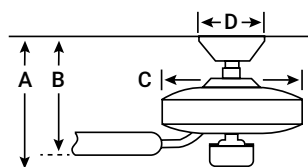

AIR PERFORMANCE

AIRFLOW
Cubic ft. per minute on high **2801**

POWER USAGE
Watts on High (excludes lights) **53.5**

AIRFLOW EFFICIENCY
Cubic ft. per minute per Watt **61**



TERNA

15" / 38cm
bladespan

Terna offers the fun and whimsy of a pinwheel, modernised. The size and scale make it ideal for use in small spaces or in multiples. Think walk in closets, dining nooks or over a desk.





Code: KLF-TERNA-15-BN
Finish: Brushed Nickel

KICHLER

INCLUDED FEATURES

- Downrods** 1 x 114mm
- Mounting Options** Standard, Angled
- Light Type** 1 x 10W LED, Integrated, Replaceable Module, Dimmable, 3000K, 80 CRI
- Light Output** 1116 lm
- Light Glass** Etched Cased Opal

FAN FEATURES

- Mounting Slope/Pitch** 22°
- Location Rating** IP20 (Dry)
- Hanging Weight** 7.28kg
- Body Material** Steel
- Warranty** Limited Lifetime

BLADE SPECS

- Blades** (5) included
- Pitch | variable°
- Material | Polycarbonate

INCLUDED CONTROLS



REMOTE CONTROL

- 3 forward speeds, reverse & motor off
- lights on/off with full-range dimming

MOTOR FEATURES

- Motor Size/Type** 153mm x 15mm, AC
- Amps** 0.158 on High
- RPM (High/Low)** 300/105

Blade Finish

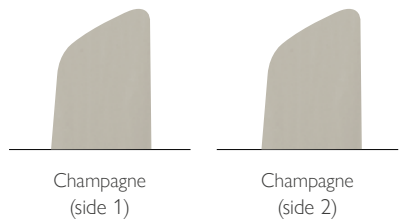

HANGING MEASUREMENTS

Min. Fixture Drop (from ceiling)	A: 50cm
Min. Blade Drop (from ceiling)	B: 49cm
Housing (width)	C: 27cm
Ceiling Canopy (width)	D: 16cm

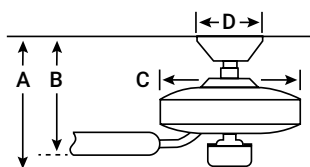

AIR PERFORMANCE

AIRFLOW Cubic ft. per minute on high	141
POWER USAGE Watts on High (excludes lights)	36.1
AIRFLOW EFFICIENCY Cubic ft. per minute per Watt	4



LED

AC

15
inch

38
cm

TERNA



KICHLER

Code: KLF-TERNA-15-BB
Finish: Oil Brushed Bronze

INCLUDED FEATURES

- Downrods** 1 x 114mm
- Mounting Options** Standard, Angled
- Light Type** 1 x 10W LED, Integrated, Replaceable Module, Dimmable, 3000K, 80 CRI
- Light Output** 1116 lm
- Light Glass** Etched Cased Opal

FAN FEATURES

- Mounting Slope/Pitch** 22°
- Location Rating** IP20 (Dry)
- Hanging Weight** 7.28kg
- Body Material** Steel
- Warranty** Limited Lifetime

BLADE SPECS

Blades (5) included	
Pitch	variable°
Material	Polycarbonate

INCLUDED CONTROLS



REMOTE CONTROL

- 3 forward speeds, reverse & motor off
- lights on/off with full-range dimming

MOTOR FEATURES

- Motor Size/Type** 153mm x 15mm, AC
- Amps** 0.158 on High
- RPM (High/Low)** 300/105

Blade Finish

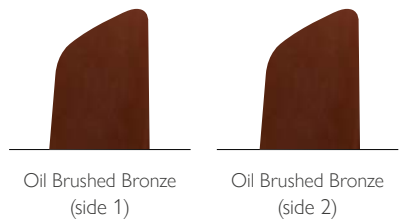

HANGING MEASUREMENTS

Min. Fixture Drop (from ceiling)	A: 50cm
Min. Blade Drop (from ceiling)	B: 49cm
Housing (width)	C: 27cm
Ceiling Canopy (width)	D: 16cm

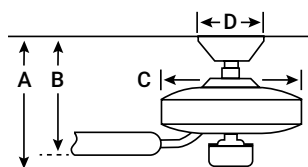

AIR PERFORMANCE	
AIRFLOW Cubic ft. per minute on high	141
POWER USAGE Watts on High (excludes lights)	36.1
AIRFLOW EFFICIENCY Cubic ft. per minute per Watt	4





OUTDOOR CEILING FANS

Keep your cool outside. Our ceiling fans bring style and airflow to your favourite al fresco entertaining spaces. Each offers premium finishes and hardware designed to withstand the elements for years of worry-free performance. Best of all: these fans can also be used indoors – so you can carry the look inside.

Be sure to choose a fan rated for your particular space. If you are uncertain, see more info on page 4.

CONTENTS

Lehr	128
Ahrendale	130
Kevlar (60"/152cm)	132
Eris	134
Outdoor Elements II	138
Lehr II	142
Maribel	144
Patio	148
Outdoor Elements II	150
Trimaran	154
Kevlar (42"/107cm)	158
Sola	160



WET

IP44

LEHR 80" / 203cm bladespan

This modern 80 inch Lehr ceiling fan brings you air with flair. The 7 long blades gently curve into the cylindrical housing creating the perfect contemporary touch for your home. This Antique Satin Silver fan is perfect for larger rooms and spaces. It is made of a composite material that is corrosion-resistant to withstand harsh outdoor elements such as extreme heat, saltwater spray, intense cold and constant UV exposure.

KICHLER



KICHLER

Code: KLF-LEHR-80-AS
Finish: Antique Satin Silver

INCLUDED FEATURES

Downrods 1 x 203mm
Mounting Options Standard, Angled

FAN FEATURES

Mounting Slope/Pitch 18°
Location Rating IP44 (Wet)
Hanging Weight 10kg
Body Material ABS
Warranty Limited Lifetime

BLADE SPECS

Blades (7) included

Pitch	12°
Material	ABS

INCLUDED CONTROLS



REMOTE CONTROL
• 6 forward speeds, reverse & motor off

MOTOR FEATURES

Motor Size/Type 165L, DC
Amps 0.23 on High
RPM (High/Low) 73/35

Blade Finish

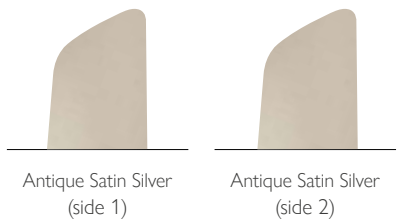

HANGING MEASUREMENTS

Min. Fixture Drop (from ceiling)	A: 51cm
Min. Blade Drop (from ceiling)	B: 34cm
Housing (width)	C: 26cm
Ceiling Canopy (width)	D: 17cm

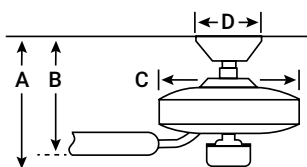

AIR PERFORMANCE	
AIRFLOW Cubic ft. per minute on high	8897
POWER USAGE Watts on High (excludes lights)	32.2
AIRFLOW EFFICIENCY Cubic ft. per minute per Watt	237

WET

IP44



AHRENDALE

60" / 152cm
bladespan

This 60 inch ceiling fan has the Anvil Iron Finish and an anvil mesh shade to add a timeworn charm over seating areas, in game rooms or anywhere you want a touch of industrial-inspired style.



KICHLER



KICHLER

Code: KLF-AHRENDALE-60-AVI

Finish: Anvil Iron

INCLUDED FEATURES

- Downrods** 1 x 114mm
- Mounting Options** Standard, Angled
- Light Type** 1 x 10W LED, Integrated, Replaceable Module, Dimmable, 3000K, 80 CRI
- Light Output** 1116 lm
- Light Glass** Etched Cased Opal

FAN FEATURES

- Mounting Slope/Pitch** 30°
- Location Rating** IP44 (Wet)
- Hanging Weight** 14.35kg
- Body Material** Steel
- Warranty** Limited Lifetime

BLADE SPECS

Blades (5) included

Pitch	12°
Material	ABS

Blade Finish



Distressed Antique Gray (side 1)



Distressed Antique Gray (sie 2)

INCLUDED CONTROLS



REMOTE CONTROL

- 3 forward speeds, reverse & motor off
- lights on/off with full-range dimming

MOTOR FEATURES

- Motor Size/Type** 188mm x 20mm, AC
- Amps** 0.28 on High
- RPM (High/Low)** 163/67

HANGING MEASUREMENTS

Min. Fixture Drop (from ceiling)	A: 42cm
Min. Blade Drop (from ceiling)	B: 25cm
Housing (width)	C: 30cm
Ceiling Canopy (width)	D: 17cm

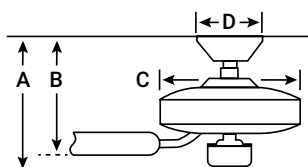

AIR PERFORMANCE

AIRFLOW Cubic ft. per minute on high	6520
POWER USAGE Watts on High (excludes lights)	64.3
AIRFLOW EFFICIENCY Cubic ft. per minute per Watt	101

WET

IP44



KEVLAR 60" / 152cm bladespan

The 60 inch Kevlar ceiling fan is IP44 rated and is an ideal choice for larger outdoor porches and patios. Smart detailing on the motor housing increases the stylish appeal. It is made of a composite material that is corrosion-resistant to withstand harsh outdoor elements such as extreme heat, saltwater spray, intense cold and constant UV exposure.



KEVLAR



KICHLER

Code: KLF-KEVLAR-60-WHT
Finish: Matte White

INCLUDED FEATURES

Downrods 1 x 114mm
Mounting Options Standard, Angled, Flush

FAN FEATURES

Mounting Slope/Pitch 18°
Location Rating IP44 (Wet)
Hanging Weight 11.9kg
Body Material Aluminum
Warranty Limited Lifetime

BLADE SPECS

Blades (5) included

Pitch	14°
Material	ABS

INCLUDED CONTROLS

PULL CHAIN

- 3 Speeds
- 3 Forward & Reverse
- Manual Reverse



MOTOR FEATURES

Motor Size/Type 188mm x 25mm, AC
Amps 0.32 on High
RPM (High/Low) 139/59

Blade Finish



HANGING MEASUREMENTS

Min. Fixture Drop (from ceiling)	A: 35cm
Min. Blade Drop (from ceiling)	B: 29cm
Housing (width)	C: 33cm
Ceiling Canopy (width)	D: 17cm

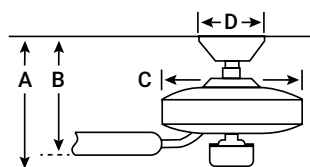

AIR PERFORMANCE	
AIRFLOW Cubic ft. per minute on high	6609
POWER USAGE Watts on High (excludes lights)	75.2
AIRFLOW EFFICIENCY Cubic ft. per minute per Watt	82

WET

IP44



ERIS

60" / 152cm
bladespan

Designed to nestle cleanly against the ceiling while still delivering a generous amount of airflow, Eris marries performance with style. Use inside or out – the sleek design, wet rating and 1,500-lumen dimmable light output bring room-filling light to a variety of gathering spaces, including open-air patios or decks.



Wet rated fans can be used indoors.



Code: KLF-ERIS-60-WN
Finish: Walnut

KICHLER

INCLUDED FEATURES

- Downrods** Not Available
- Mounting Options** Flush
- Light Type** 1 x 10W LED, Integrated, Replaceable Module, Dimmable, 3000K, 80 CRI
- Light Output** 1116 lm
- Light Glass** Etched Cased Opal

INCLUDED CONTROLS



REMOTE CONTROL

- 3 forward speeds, reverse & motor off
- lights on/off with full-range dimming

FAN FEATURES

- Location Rating** IP44 (Wet)
- Hanging Weight** 11.69kg
- Body Material** ABS
- Warranty** Limited Lifetime

MOTOR FEATURES

- Motor Size/Type** 188mm x 20mm, AC
- Amps** 0.289 on High
- RPM (High/Low)** 127/55

BLADE SPECS

Blades (3) included

Pitch	25°
Material	ABS

Blade Finish

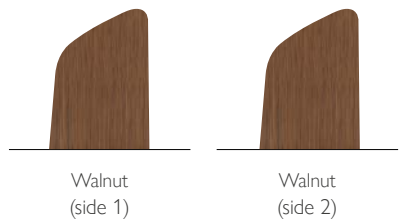

HANGING MEASUREMENTS

Min. Fixture Drop (from ceiling)	A: 29cm
Min. Blade Drop (from ceiling)	B: 23cm
Housing (width)	C: 25cm
Ceiling Canopy (width)	D: 20cm

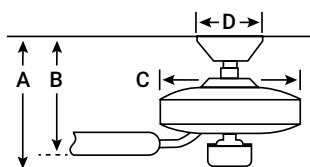

AIR PERFORMANCE

AIRFLOW Cubic ft. per minute on high	4043
POWER USAGE Watts on High (excludes lights)	66.4
AIRFLOW EFFICIENCY Cubic ft. per minute per Watt	61



ERIS



KICHLER

Code: KLF-ERIS-60-BN

Finish: Brushed Nickel

INCLUDED FEATURES

- Downrods** Not Available
- Mounting Options** Flush
- Light Type** 1 x 10W LED, Integrated, Replaceable Module, Dimmable, 3000K, 80 CRI
- Light Output** 1116 lm
- Light Glass** Etched Cased Opal

FAN FEATURES

- Location Rating** IP44 (Wet)
- Hanging Weight** 11.69kg
- Body Material** ABS
- Warranty** Limited Lifetime

BLADE SPECS

Blades (3) included

Pitch	25°
Material	ABS

Blade Finish

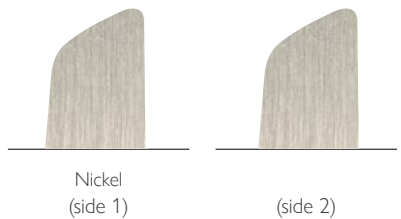

INCLUDED CONTROLS



REMOTE CONTROL

- 3 forward speeds, reverse & motor off
- lights on/off with full-range dimming

MOTOR FEATURES

- Motor Size/Type** 188mm x 20mm, AC
- Amps** 0.289 on High
- RPM (High/Low)** 127/55

HANGING MEASUREMENTS

Min. Fixture Drop (from ceiling)	A: 29cm
Min. Blade Drop (from ceiling)	B: 23cm
Housing (width)	C: 25cm
Ceiling Canopy (width)	D: 20cm

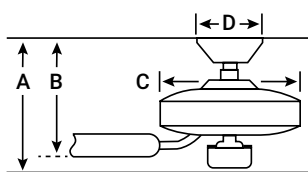

AIR PERFORMANCE	
AIRFLOW Cubic ft. per minute on high	4043
POWER USAGE Watts on High (excludes lights)	66.4
AIRFLOW EFFICIENCY Cubic ft. per minute per Watt	61

WET

IP44



OUTDOOR ELEMENTS II 54" / 137cm bladespan

The Outdoor Elements II ceiling fans are IP44-rated and so can be safely used in wet conditions. This model features blades with a unique Palm Leaf pattern on one side and Wicker on the other to give a choice of natural looking styles to complement any outdoor space.





Code: HT-24323
Finish: New Bronze



INCLUDED FEATURES

Downrods 1 x 76mm
Mounting Options Standard, Angled
 Light kit Adaptable (see page 165)

FAN FEATURES

Mounting Slope/Pitch 35°
Location Rating IP44 (Wet)
Hanging Weight 10.4kg
Body Material Aluminum
Warranty Limited Lifetime Motor

BLADE SPECS

Blades (5) included

Pitch	14°
Material	Plastic

Blade Finish



Antique Dark
Wicker
(side 1)



Antique Dark Palm
Leaves
(side 2)

INCLUDED CONTROLS



PULL CHAIN
 • 3 forward speeds & motor off

MOTOR FEATURES

Motor Size/Type 172mm x 20mm, AC
Amps 0.239 on High
RPM (High/Low) 143/72

HANGING MEASUREMENTS

Min. Fixture Drop (from ceiling)	A: 35.7cm
Min. Blade Drop (from ceiling)	B: 31.4cm
Housing (width)	C: 29.2cm
Ceiling Canopy (width)	D: 16.3cm

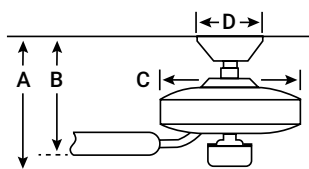

AIR PERFORMANCE

AIRFLOW Cubic ft. per minute on high	5370
POWER USAGE Watts on High (excludes lights)	52
AIRFLOW EFFICIENCY Cubic ft. per minute per Watt	103



Code: HT-24325

Finish: Raw Aluminum

INCLUDED FEATURES

Downrods 1 x 76mm
Mounting Options Standard, Angled
 Light kit Adaptable (see page 165)

FAN FEATURES

Mounting Slope/Pitch 35°
Location Rating IP44 (Wet)
Hanging Weight 10.4kg
Body Material Aluminum
Warranty Limited Lifetime Motor

BLADE SPECS

Blades (5) included

Pitch	14°
Material	Plastic

Blade Finish



Natural Ruby Wicker (side 1)



Natural Ruby Palm Leaf (side 2)

INCLUDED CONTROLS



PULL CHAIN

- 3 forward speeds & motor off

MOTOR FEATURES

Motor Size/Type 172mm x 20mm, AC
Amps 0.239 on High
RPM (High/Low) 143/72

HANGING MEASUREMENTS

Min. Fixture Drop (from ceiling)	A: 35.7cm
Min. Blade Drop (from ceiling)	B: 31.4cm
Housing (width)	C: 29.2cm
Ceiling Canopy (width)	D: 16.3cm

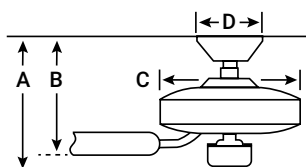

AIR PERFORMANCE

AIRFLOW Cubic ft. per minute on high	5370
POWER USAGE Watts on High (excludes lights)	52
AIRFLOW EFFICIENCY Cubic ft. per minute per Watt	103



WET

IP44

LEHR II

54" / 137cm
bladespan

The Lehr™ II, in Antique Satin Silver is a smaller 54-inch model, making it practical for residential applications. The Lehr™ II is made of a composite material that is corrosion-resistant to withstand harsh outdoor elements such as extreme heat, saltwater spray, intense cold and constant UV exposure.

KICHLER



KICHLER

Code: KLF-LEHR2-54-AS
Finish: Antique Satin Silver

INCLUDED FEATURES

Downrods 1 x 203mm
Mounting Options Standard, Angled

FAN FEATURES

Mounting Slope/Pitch 18°
Location Rating IP44 (Wet)
Hanging Weight 6.9kg
Body Material ABS
Warranty Limited Lifetime

BLADE SPECS

Blades (7) included
Pitch | 12°
Material | ABS

INCLUDED CONTROLS



REMOTE CONTROL
• 6 forward speeds, reverse & motor off

MOTOR FEATURES

Motor Size/Type 125, DC
Amps 0.2 on High
RPM (High/Low) 107/45

Blade Finish



HANGING MEASUREMENTS

Min. Fixture Drop (from ceiling)	A: 51cm
Min. Blade Drop (from ceiling)	B: 34cm
Housing (width)	C: 26cm
Ceiling Canopy (width)	D: 17cm

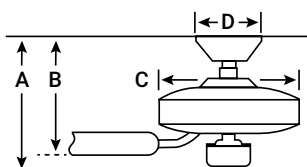

AIR PERFORMANCE	
AIRFLOW Cubic ft. per minute on high	5603
POWER USAGE Watts on High (excludes lights)	27.3
AIRFLOW EFFICIENCY Cubic ft. per minute per Watt	165

WET

IP44



MARIBEL

52" / 132cm
bladespan

The Maribel ceiling fan is IP44-rated and so can be safely used in wet conditions. It features a slim profile with sleek transitional styled elements, available in either a New Bronze or White finish with complementary coloured plastic blades. The adjustable design offers two mounting options; standard or angled for sloped ceilings.



MARIBEL



Code: HT-50555

Finish: New Bronze

INCLUDED FEATURES

Downrods 1 x 76mm
Mounting Options Standard, Angled
Light kit Adaptable (see page 165)

FAN FEATURES

Mounting Slope/Pitch 35°
Location Rating IP44 (Wet)
Hanging Weight 8.8kg
Body Material Aluminum
Warranty Limited Lifetime Motor

BLADE SPECS

Blades (5) included

Pitch	13°
Material	Plastic

Blade Finish



Walnut (side 1)



Walnut (side 2)

INCLUDED CONTROLS



PULL CHAIN

- 3 forward speeds & motor off

MOTOR FEATURES

Motor Size/Type 172mm x 20mm, AC
Amps 0.292 on High
RPM (High/Low) 193/84

HANGING MEASUREMENTS

Min. Fixture Drop (from ceiling)	A: 31.3cm
Min. Blade Drop (from ceiling)	B: 28.9cm
Housing (width)	C: 31cm
Ceiling Canopy (width)	D: 17.2cm

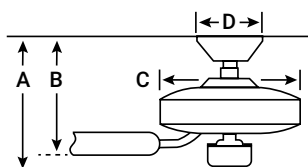

AIR PERFORMANCE

AIRFLOW Cubic ft. per minute on high	6068
POWER USAGE Watts on High (excludes lights)	63
AIRFLOW EFFICIENCY Cubic ft. per minute per Watt	96

WET

IP44



MARIBEL

52" / 132cm
bladespan

The Maribel ceiling fan is IP44-rated and so can be safely used in wet conditions. It features a slim profile with sleek transitional styled elements, available in either a New Bronze or White finish with complementary coloured plastic blades. The adjustable design offers two mounting options; standard or angled for sloped ceilings.



MARIBEL



Hunter

Code: HT-50557

Finish: White

INCLUDED FEATURES

Downrods 1 x 76mm
Mounting Options Standard, Angled
Light kit Adaptable (see page 165)

FAN FEATURES

Mounting Slope/Pitch 35°
Location Rating IP44 (Wet)
Hanging Weight 8.8kg
Body Material Aluminum
Warranty Limited Lifetime Motor

BLADE SPECS

Blades (5) included

Pitch	13°
Material	Plastic

Blade Finish



INCLUDED CONTROLS



PULL CHAIN

- 3 forward speeds & motor off

MOTOR FEATURES

Motor Size/Type 172mm x 20mm, AC
Amps 0.292 on High
RPM (High/Low) 193/84

HANGING MEASUREMENTS

Min. Fixture Drop (from ceiling)	A: 31.3cm
Min. Blade Drop (from ceiling)	B: 28.9cm
Housing (width)	C: 31cm
Ceiling Canopy (width)	D: 17.2cm

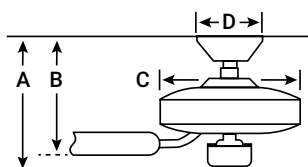

AIR PERFORMANCE

AIRFLOW Cubic ft. per minute on high	6068
POWER USAGE Watts on High (excludes lights)	63
AIRFLOW EFFICIENCY Cubic ft. per minute per Watt	96

DAMP

IP23



LYNDON PATIO

52" / 132cm
bladespan

The 52 inch Lyndon Patio fan is finished in Olde Bronze with reversible blades in either Medium or Dark Walnut. It co-ordinates with the Lyndon outdoor collection and is IP23 rated for covered outdoor living areas.



LYNDON PATIO



KICHLER

Code: KLF-LYNDON-52-OZ

Finish: Olde Bronze

INCLUDED FEATURES

- Downrods** 1 x 114mm
- Mounting Options** Standard, Angled
- Light Type** 3 x 8W LED E27, Bulbs Not Included
- Light Glass** Clear Seeded

FAN FEATURES

- Mounting Slope/Pitch** 30°
- Location Rating** IP23 (Damp)
- Hanging Weight** 10.67kg
- Body Material** Steel
- Warranty** Limited Lifetime

BLADE SPECS

Blades (5) included

Pitch	13°
Material	ABS

Blade Finish



Medium Walnut (side 1)



Dark Walnut (side 2)

INCLUDED CONTROLS



REMOTE CONTROL

- 3 forward speeds & motor off
- lights on/off

MOTOR FEATURES

- Motor Size/Type** 172mm x 15mm, AC
- Amps** 0.238 on High
- RPM (High/Low)** 156/75

HANGING MEASUREMENTS

Min. Fixture Drop (from ceiling)	A: 48cm
Min. Blade Drop (from ceiling)	B: 34cm
Housing (width)	C: 24cm
Ceiling Canopy (width)	D: 17cm

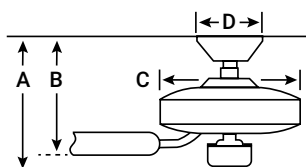

AIR PERFORMANCE

AIRFLOW Cubic ft. per minute on high	4915
POWER USAGE Watts on High (excludes lights)	54.7
AIRFLOW EFFICIENCY Cubic ft. per minute per Watt	90

WET

IP44



OUTDOOR ELEMENTS II 52" / 132cm bladespan

The Outdoor Elements II ceiling fans are IP44-rated and so can be safely used in wet conditions. This model features five blades made from Solid Teak and has a Weathered Brick finish. The adjustable design allows for installation on standard or angled ceilings.



Code: HT-24324

Finish: Weathered Brick

INCLUDED FEATURES

Downrods 1 x 76mm
Mounting Options Standard, Angled
 Light kit Adaptable (see page 165)

FAN FEATURES

Mounting Slope/Pitch 35°
Location Rating IP44 (Wet)
Hanging Weight 9.5kg
Body Material Aluminum
Warranty Limited Lifetime Motor

BLADE SPECS

Blades (5) included
 Pitch 14°
 Material Carved Wood

INCLUDED CONTROLS



PULL CHAIN
 • 3 forward speeds & motor off

MOTOR FEATURES

Motor Size/Type 172mm x 20mm, AC
Amps 0.239 on High
RPM (High/Low) 143/72

Blade Finish



Teak (side 1)



Teak (side 2)

HANGING MEASUREMENTS

Min. Fixture Drop (from ceiling)	A: 35.7cm
Min. Blade Drop (from ceiling)	B: 31.4cm
Housing (width)	C: 29.2cm
Ceiling Canopy (width)	D: 16.3cm

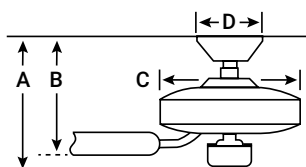

AIR PERFORMANCE

AIRFLOW Cubic ft. per minute on high	5370
POWER USAGE Watts on High (excludes lights)	52
AIRFLOW EFFICIENCY Cubic ft. per minute per Watt	103

WET



IP44



OUTDOOR ELEMENTS II 52" / 132cm bladespan

The Outdoor Elements II ceiling fans are IP44-rated and so can be safely used in wet conditions. The White model features five White plastic blades with a slight curved peak on their tips. The adjustable design allows for installation on standard or angled ceilings.



Code: HT-24326
Finish: Satin White

INCLUDED FEATURES

Downrods 1 x 76mm
Mounting Options Standard, Angled
Light kit Adaptable (see page 165)

FAN FEATURES

Mounting Slope/Pitch 35°
Location Rating IP44 (Wet)
Hanging Weight 10.3kg
Body Material Aluminum
Warranty Limited Lifetime Motor

BLADE SPECS

Blades (5) included

Pitch	14°
Material	Plastic

Blade Finish



INCLUDED CONTROLS



PULL CHAIN

- 3 forward speeds & motor off

MOTOR FEATURES

Motor Size/Type 172mm x 20mm, AC
Amps 0.239 on High
RPM (High/Low) 143/72

HANGING MEASUREMENTS

Min. Fixture Drop (from ceiling)	A: 35.7cm
Min. Blade Drop (from ceiling)	B: 31.4cm
Housing (width)	C: 29.2cm
Ceiling Canopy (width)	D: 16.3cm

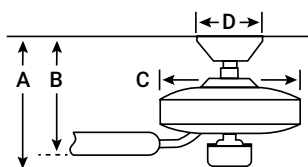

AIR PERFORMANCE

AIRFLOW Cubic ft. per minute on high	5370
POWER USAGE Watts on High (excludes lights)	52
AIRFLOW EFFICIENCY Cubic ft. per minute per Watt	103

WET



IP44



TRIMARAN 52" / 132cm bladespan

Pergolas and patios stay cool and stylish with the Trimaran modern outdoor ceiling fan. This wet-rated fan is corrosion-resistant, salt-air resistant, and engineered for the elements. It's a perfect fit for large outdoor spaces in beachside and lakefront homes.





Code: HT-50942
Finish: Fresh White



INCLUDED FEATURES

Downrods 1 x 102mm & 1 x 51mm
Mounting Options Standard, Angled, Flush

FAN FEATURES

Mounting Slope/Pitch 35°
Location Rating IP44 (Wet)
Hanging Weight 8.7kg
Body Material Aluminum
Warranty Limited Lifetime Motor

BLADE SPECS

Blades (3) included
Material | Plastic

INCLUDED CONTROLS



WALL CONTROL

- 3 forward speeds & motor off
- includes 2 plates, square and rectangle

MOTOR FEATURES

Motor Size/Type 172mm x 20mm, AC
RPM (High) 167

Blade Finish



Fresh White
(side 1)



Fresh White
(side 2)

HANGING MEASUREMENTS

Min. Fixture Drop (from ceiling)	A: 32cm
Min. Blade Drop (from ceiling)	B: 28.1cm
Housing (width)	C: 25cm
Ceiling Canopy (width)	D: 17.1cm

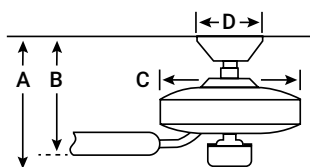

AIR PERFORMANCE

AIRFLOW Cubic ft. per minute on high	5383
POWER USAGE Watts on High (excludes lights)	64
AIRFLOW EFFICIENCY Cubic ft. per minute per Watt	84



TRIMARAN



Code: HT-50943

Finish: Premier Bronze

INCLUDED FEATURES

Downrods 1 x 102mm & 1 x 51mm
Mounting Options Standard, Angled, Flush

FAN FEATURES

Mounting Slope/Pitch 35°
Location Rating IP44 (Wet)
Hanging Weight 8.7kg
Body Material Aluminum
Warranty Limited Lifetime Motor

BLADE SPECS

Blades (3) included
Material | Plastic

INCLUDED CONTROLS



WALL CONTROL

- 3 forward speeds & motor off
- includes 2 plates, square and rectangle

MOTOR FEATURES

Motor Size/Type 172mm x 20mm, AC
RPM (High) 167

Blade Finish

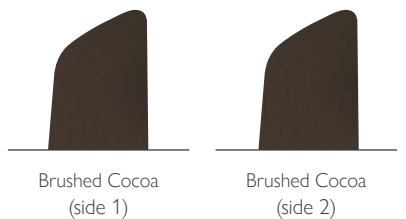

HANGING MEASUREMENTS

Min. Fixture Drop (from ceiling)	A: 32cm
Min. Blade Drop (from ceiling)	B: 28.2cm
Housing (width)	C: 24.9cm
Ceiling Canopy (width)	D: 17.1cm

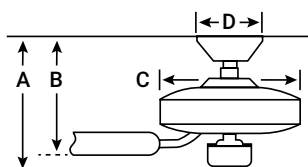

AIR PERFORMANCE	
AIRFLOW Cubic ft. per minute on high	5383
POWER USAGE Watts on High (excludes lights)	64
AIRFLOW EFFICIENCY Cubic ft. per minute per Watt	84

WET

IP44



KEVLAR 42" / 107cm bladespan

The 42 inch Kevlar ceiling fan is IP44 rated and is an ideal choice for larger outdoor porches and patios. Smart detailing on the motor housing increases the stylish appeal. It is made of a composite material that is corrosion-resistant to withstand harsh outdoor elements such as extreme heat, saltwater spray, intense cold and constant UV exposure.



KEVLAR



KICHLER

Code: KLF-KEVLAR-42-WHT

Finish: Matte White

INCLUDED FEATURES

Downrods 1 x 114mm
Mounting Options Standard, Angled, Flush

FAN FEATURES

Mounting Slope/Pitch 30°
Location Rating IP44 (Wet)
Hanging Weight 8.1kg
Body Material Aluminum
Warranty Limited Lifetime

BLADE SPECS

Blades (5) included

Pitch	14°
Material	ABS

INCLUDED CONTROLS

PULL CHAIN

- 3 Speeds
- 3 Forward & Reverse
- Manual Reverse



MOTOR FEATURES

Motor Size/Type 153mm x 18mm, AC
Amps 0.24 on High
RPM (High/Low) 214/100

Blade Finish



HANGING MEASUREMENTS

Min. Fixture Drop (from ceiling)	A: 35cm
Min. Blade Drop (from ceiling)	B: 29cm
Housing (width)	C: 33cm
Ceiling Canopy (width)	D: 17cm

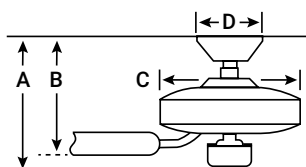

AIR PERFORMANCE

AIRFLOW Cubic ft. per minute on high	3939
POWER USAGE Watts on High (excludes lights)	56.8
AIRFLOW EFFICIENCY Cubic ft. per minute per Watt	74

DAMP

IP23



SOLA 34" / 86cm bladespan

The Sola collection from Kichler is available in Matte White and Brushed Nickel. It can be used outside and features integrated dimmable LED lighting and flush mount installation. The globe inspired motor housing shape brings delightful style to any space. A metal fixture cap is included for non-light use installations.



Damp rated fans can be used indoors.



Code: KLF-SOLA-34-WHT
Finish: Matte White



INCLUDED FEATURES

- Downrods** Not Available
- Mounting Options** Flush
- Light Type** 1 x 10W LED, Integrated, Replaceable Module, Dimmable, 3000K, 80 CRI
- Light Output** 1116 lm
- Light Glass** Etched Cased Opal

INCLUDED CONTROLS



REMOTE CONTROL

- 3 forward speeds, reverse & motor off
- lights on/off with full-range dimming

FAN FEATURES

- Location Rating** IP23 (Damp)
- Hanging Weight** 6.94kg
- Body Material** Steel
- Warranty** Limited Lifetime

MOTOR FEATURES

- Motor Size/Type** 172mm x 12mm, AC
- Amps** 0.234 on High
- RPM (High/Low)** 247/123

BLADE SPECS

Blades (3) included

Pitch	22°
Material	ABS

Blade Finish



HANGING MEASUREMENTS

Min. Fixture Drop (from ceiling)	A: 28cm
Min. Blade Drop (from ceiling)	B: 18cm
Housing (width)	C: 22cm
Ceiling Canopy (width)	D: 17cm

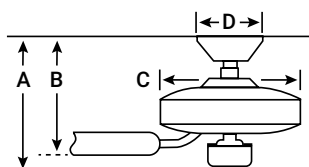

AIR PERFORMANCE

AIRFLOW Cubic ft. per minute on high	4048
POWER USAGE Watts on High (excludes lights)	53.8
AIRFLOW EFFICIENCY Cubic ft. per minute per Watt	75



KICHLER

Code: KLF-SOLA-34-BN
Finish: Brushed Nickel

INCLUDED FEATURES

- Downrods** Not Available
- Mounting Options** Flush
- Light Type** 1 x 10W LED, Integrated, Replaceable Module, Dimmable, 3000K, 80 CRI
- Light Output** 1116 lm
- Light Glass** Etched Cased Opal

FAN FEATURES

- Location Rating** IP23 (Damp)
- Hanging Weight** 6.94kg
- Body Material** Steel
- Warranty** Limited Lifetime

BLADE SPECS

Blades (3) included

Pitch	22°
Material	ABS

INCLUDED CONTROLS



REMOTE CONTROL

- 3 forward speeds, reverse & motor off
- lights on/off with full-range dimming

MOTOR FEATURES

- Motor Size/Type** 172mm x 12mm, AC
- Amps** 0.234 on High
- RPM (High/Low)** 247/123

Blade Finish

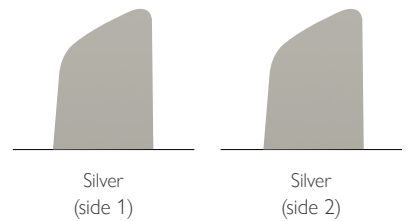

HANGING MEASUREMENTS

Min. Fixture Drop (from ceiling)	A: 28cm
Min. Blade Drop (from ceiling)	B: 18cm
Housing (width)	C: 22cm
Ceiling Canopy (width)	D: 17cm

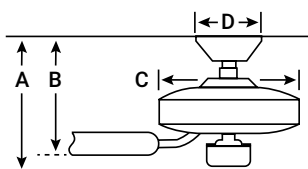

AIR PERFORMANCE

AIRFLOW Cubic ft. per minute on high	4048
POWER USAGE Watts on High (excludes lights)	53.8
AIRFLOW EFFICIENCY Cubic ft. per minute per Watt	75

KICHLER DOWNROD EXTENSIONS

All semi-flush ceiling fans come complete with one short downrod between 4 - 7" long (102 - 203mm). You can check the downrod section on each product page to find out what the length is for your chosen fan. This rod can be added to or replaced with our downrod extension accessories.



Satin White Painted

Length	Product Code
6" (15cm)	CLF-DOWNROD15-SWP
12" (30cm)	CLF-DOWNROD30-SWP
18" (45cm)	CLF-DOWNROD45-SWP



Satin Black Painted

Length	Product Code
6" (15cm)	CLF-DOWNROD15-SBP
12" (30cm)	CLF-DOWNROD30-SBP
18" (45cm)	CLF-DOWNROD45-SBP



Old Bronze Painted

Length	Product Code
6" (15cm)	CLF-DOWNROD15-OBP
12" (30cm)	CLF-DOWNROD30-OBP
18" (45cm)	CLF-DOWNROD45-OBP



Satin Nickel Painted

Length	Product Code
6" (15cm)	CLF-DOWNROD15-SNP
12" (30cm)	CLF-DOWNROD30-SNP
18" (45cm)	CLF-DOWNROD45-SNP



Image: KLF-XETY-56-OZ shown with Old Bronze downrods

HUNTER LIGHT ACCESSORIES



Flight Light Kit
50900
 Includes finials in White and Brushed Nickel
 Two E27 sockets
 Rated at max 13-watt



Contemporary Light Kit
24301 Brushed Nickel (shown)
24304 Graphite
24307 White
 One E27 socket
 Rated at max 60-watt



Opal Schoolhouse Globe
22515 - 8" Globe (shown)
22555 - 10" Globe
 Glass only



Contemporary Schoolhouse Globe
22565
 Glass only



Swirled Marble Bowl
24127
 Includes finials in Brushed Nickel, Bright Brass, Antique Brass, White, and New Bronze
 Two E27 sockets
 Rated at max 60-watt



Scavo Bowl
24122
 Includes finials in Brushed Nickel, Satin Brass, White, and Bright Brass
 Two E27 sockets
 Rated at max 60-watt



Amber Bowl
24125
 Includes finials in New Bronze, Amber Bronze, Antique Brass, and Weathered Bronze
 Two E27 sockets
 Rated at max 60-watt



Frosted Opal Bowl
24126
 Includes finials in Brushed Nickel, Bright Brass, Antique Brass, White, and New Bronze
 Two E27 sockets
 Rated at max 60-watt



3 Light Flush Mount
24310 - Antique Brass
24312 - Bright Brass
24316 - White
24318 - Brushed Nickel
24319 - New Bronze (shown)
 Three E27 sockets
 Rated at max 60-watt



Globe Adapter
24432 - White (shown)
24434 - Bright Brass
24435 - Brushed Chrome



Angra Outdoor Light Kit
50910 - New Bronze (shown)
50911 - White
 One E27 socket
 Rated at max 60-watt



Wet rated



Outdoor Light Kit
24335 - New Bronze (shown)
24336 - White
24337 - Raw Aluminum
 Two E27 sockets
 Rated at max 13-watt



Wet rated

HUNTER CONTROLS



3-Speed and light dimming remote
99390







240v 3-Speed Wall Control (w/Light)
24757
 Includes 2 wall plates: square and rectangular



240v 3-Speed Wall Control (No Light)
24758
 Includes 2 wall plates: square and rectangular

HUNTER DOWNROD EXTENSIONS

	12" (30cm)	18" (45cm)	24" (61cm)	36" (91cm)	48" (122cm)	60" (152cm)	72" (183cm)
 Antique Brass Indoor	22719	22729	26319	26329	26339	23190	23060
 Black Indoor	25144	25145	25146	25147	25148	25149	25150
 Bronze Patina Indoor	28206	28207	28208	28209	28210	x	x
 Brushed Nickel Indoor	26019	26020	26021	26022	26023	26024	26025
 Fresh White Indoor	99700	99701	99702	99703	99704	99705	99706
 Matte Silver Indoor	99301	99302	99303	99304	99305	99306	99307
 New Bronze Indoor	26041	26042	26043	26044	26045	26046	26047
 Noble Bronze Indoor	99294	99295	99296	99297	99298	99299	99300
 Premier Bronze Indoor	99708	99709	99710	99711	99712	99713	99714

	12" (30cm)	18" (45cm)	24" (61cm)	36" (91cm)	48" (122cm)	60" (152cm)	72" (183cm)
 Matte Silver All-Weather	99730	99731	99732	99733	99734	x	x
 Matte Black All-Weather	99738	99739	99740	99741	99742	x	x
 Fresh White All-Weather	99746	99747	99748	99749	99750	x	x
 Noble Bronze All-Weather	99755	99756	99757	99758	99759	x	x

Hunter Downrods are 3/4" (19mm) diameter.



Image: HT-50629 shown with Fresh White downrods



Image: Titan industrial fans - see page 176



COMMERCIAL AND INDUSTRIAL CEILING FANS

These fans are purposefully made with large open spaces in mind. They are ideal for industrial and commercial buildings where openings to the outdoors and constant throughfair make it impractical to control the temperature with air-conditioning.

We have many customisation options available, from finish and size to input power options to ensure we have the right fans for you.

CONTENTS

Trak (commercial)	170-173
Titan (industrial)	176-177
Eco (industrial)	178-179



TRAK

3 finishes
4 sizes

The Trak modern commercial ceiling fan collection will update your indoor and outdoor spaces including restaurants, hotels, and sport facilities. The Trak ceiling fan is designed and engineered with a commercial grade motor and extracted aluminum blades for a long lifespan and optimal airflow in large, open spaces.





TRAK



LIGHT OPTIONAL



SIZES AVAILABLE

60 inch | 152 cm

72 inch | 182 cm

84 inch | 213 cm

96 inch | 243 cm

Finish: Matte Black

Custom made to order

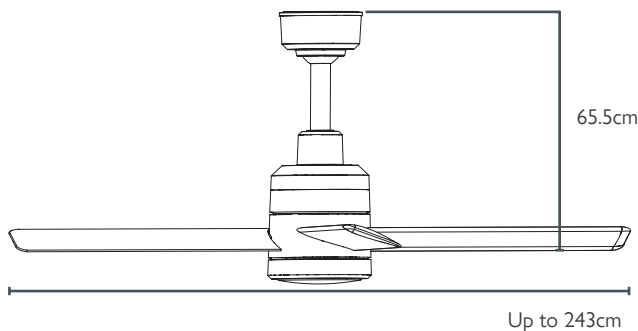

Motor	Reversible, 8-speed DC Motor
Optional Light	30W LED, 900 Lumens, 30 LM/W
Blades Material	6061-T6 Aircraft Grade aluminium
Housing Material	Prime Plastic
Safety Cable	1/4" 7x19 Safety Cable
Finish Colours	Fresh White, Matte Silver, Matte Black
Control options	Remote control included
Downrod Sizes	24" / 60cm, 36" / 91cm, 48" / 122cm, 60" / 152cm Included standard downrod 11" / 28cm
Warranty	3 years

DIAMETER	LOCATION	MAX. AMPS	MAX. AFFECTED AREA	MAX. VELOCITY	CFM*1	FAN WATTS AT MAX.*2	WEIGHT
60" / 152cm	Indoor & Outdoor. IP45	1.16A	20ft diameter / 400 sq. ft 6m diameter / 37.16m ²	9.82 MPH 4.39 M/S	13,032	91.2	48 Lbs 21.77 kg
72" / 182cm	Indoor & Outdoor. IP45	1.16A	24ft diameter / 576 sq. ft 7.31m diameter / 53.51m ²	9.31 MPH 4.16 M/S	17,895	103	48.5 Lbs 22 kg
84" / 213cm	Indoor & Outdoor. IP45	1.16A	28ft diameter / 784 sq. ft 8.53m diameter / 72.83m ²	8.51 MPH 3.80 M/S	22,110	90.7	49 Lbs 22.22 kg
96" / 243cm	Indoor & Outdoor. IP45	1.16A	32ft diameter / 1,024 sq. ft 9.75m diameter / 95.13m ²	8 MPH 3.75 M/S	24,758	118.7	49.5 Lbs 22.45 kg

*1 CFM AMCA 230-15 *2 Wattage data without light.



LIGHT OPTIONAL



SIZES AVAILABLE

Finish: Fresh White

60 inch | 152 cm | 72 inch | 182 cm | 84 inch | 213 cm | 96 inch | 243 cm

Custom made to order

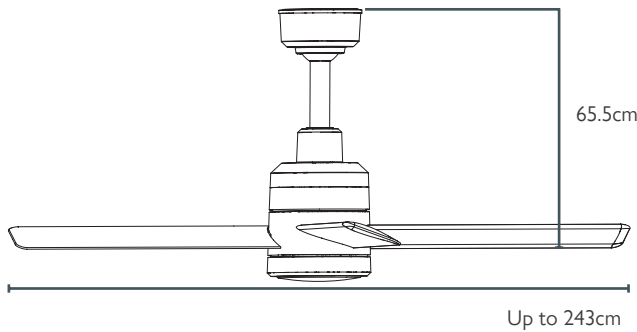

Motor	Reversible, 8-speed DC Motor
Optional Light	30W LED, 900 Lumens, 30 LM/W
Blades Material	6061-T6 Aircraft Grade aluminium
Housing Material	Prime Plastic
Safety Cable	1/4" 7x19 Safety Cable
Finish Colours	Fresh White, Matte Silver, Matte Black
Control options	Remote control included
Downrod Sizes	24" / 60cm, 36" / 91cm, 48" / 122cm, 60" / 152cm Included standard downrod 11" / 28cm
Warranty	3 years

DIAMETER	LOCATION	MAX. AMPS	MAX. AFFECTED AREA	MAX. VELOCITY	CFM*1	FAN WATTS AT MAX.*2	WEIGHT
60" / 152cm	Indoor & Outdoor. IP45	1.16A	20ft diameter / 400 sq. ft 6m diameter / 37.16m ²	9.82 MPH 4.39 M/S	13,032	91.2	48 Lbs 21.77 kg
72" / 182cm	Indoor & Outdoor. IP45	1.16A	24ft diameter / 576 sq. ft 7.31m diameter / 53.51m ²	9.31 MPH 4.16 M/S	17,895	103	48.5 Lbs 22 kg
84" / 213cm	Indoor & Outdoor. IP45	1.16A	28ft diameter / 784 sq. ft 8.53m diameter / 72.83m ²	8.51 MPH 3.80 M/S	22,110	90.7	49 Lbs 22.22 kg
96" / 243cm	Indoor & Outdoor. IP45	1.16A	32ft diameter / 1,024 sq. ft 9.75m diameter / 95.13m ²	8 MPH 3.75 M/S	24,758	118.7	49.5 Lbs 22.45 kg

*1 CFM AMCA 230-15 *2 Wattage data without light.



TRAK



LIGHT OPTIONAL



SIZES AVAILABLE

60 inch | 152 cm

72 inch | 182 cm

84 inch | 213 cm

96 inch | 243 cm

Finish: Matte Silver

Custom made to order

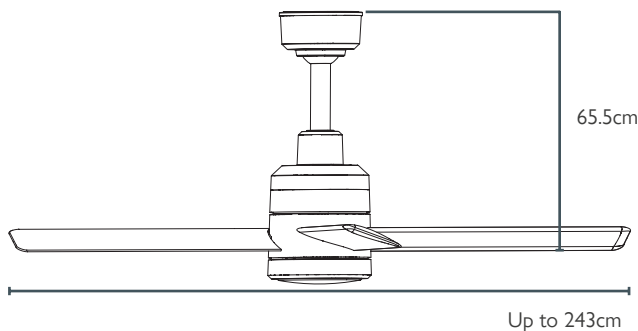

Motor	Reversible, 8-speed DC Motor
Optional Light	30W LED, 900 Lumens, 30 LM/W
Blades Material	6061-T6 Aircraft Grade aluminium
Housing Material	Prime Plastic
Safety Cable	1/4" 7x19 Safety Cable
Finish Colours	Fresh White, Matte Silver, Matte Black
Control options	Remote control included
Downrod Sizes	24" / 60cm, 36" / 91cm, 48" / 122cm, 60" / 152cm Included standard downrod 11" / 28cm
Warranty	3 years

DIAMETER	LOCATION	MAX. AMPS	MAX. AFFECTED AREA	MAX. VELOCITY	CFM*1	FAN WATTS AT MAX.*2	WEIGHT
60" / 152cm	Indoor & Outdoor. IP45	1.16A	20ft diameter / 400 sq. ft 6m diameter / 37.16m ²	9.82 MPH 4.39 M/S	13,032	91.2	48 Lbs 21.77 kg
72" / 182cm	Indoor & Outdoor. IP45	1.16A	24ft diameter / 576 sq. ft 7.31m diameter / 53.51m ²	9.31 MPH 4.16 M/S	17,895	103	48.5 Lbs 22 kg
84" / 213cm	Indoor & Outdoor. IP45	1.16A	28ft diameter / 784 sq. ft 8.53m diameter / 72.83m ²	8.51 MPH 3.80 M/S	22,110	90.7	49 Lbs 22.22 kg
96" / 243cm	Indoor & Outdoor. IP45	1.16A	32ft diameter / 1,024 sq. ft 9.75m diameter / 95.13m ²	8 MPH 3.75 M/S	24,758	118.7	49.5 Lbs 22.45 kg

*1 CFM AMCA 230-15 *2 Wattage data without light.

WHAT ARE HIGH VOLUME LOW SPEED (HVLS) FANS?

High Volume Low Speed (HVLS) fans move large quantities of air down towards the floor at a low speed. When the air columns hit the floor, it changes direction and moves the air outward in a 360-degree direction, which then migrates to every nook and corner of the workspace.

The wind created by the fan mimics a natural breeze-like feeling on the skin that feels like its 4-5°C cooler, which is far more comfortable than wind produced by an ordinary HVAC system.

LOW ENERGY CONSUMPTION

HVLS fans can reduce winter destratification and summer cooling costs by as much as 30%. HVLS fans cost just pennies an hour to operate. The result: Your HVLS fan investment will likely pay for itself in less than a year.

Air conditioning a large building can be expensive and complex. Size, occupancy, loading docks, and large doors and windows make consistent indoor climate control difficult. A HVLS fan can help move air-conditioned air throughout the facility, keeping temperatures consistent, and in many cases, allow the thermostat set point to be raised by up to 4 degrees while maintaining the same level of comfort.

A HVLS fan redirects warm air at the ceiling to the floor level, while cooler air at the floor is pulled up - reducing unnecessary heating and cutting energy use by up to 30%.

WHY HUNTER?

Hunter make the most efficient fans in the world, which gives you massive performance while using less power. Less power leads to lower operating cost and year-round saving for you. Save on energy usage compared to other HVLS fans and up to 12 times the air movement of conventional high-speed fans.

HVLS FAN BENEFITS



Refresh environment's temperature



Avoid heat and fatigue accidents in employees



Provide a constant airflow inside installation area



Distribute, mix and move air throughout the area, avoiding hot/cold spots



Reduce dust



Reduce relative humidity, creating a drier and cooler environment



Get rid of insects inside finished product area or general working areas



Reduce strong odors



TITAN

1 finish
5 sizes

The Titan features the first direct drive motor designed specifically for this industry. It has pre-wired downrods and pre-aligned mounting brackets, making install a breeze. It's the most efficient technology in the ceiling fan industry, allowing widespread air movement, lower operating costs, and year-round savings.

Hunter



AC

TITAN



SIZES AVAILABLE



14 ft	4.3 m	16 ft	4.9 m	18 ft	5.5 m	20 ft	6.1 m	24 ft	7.3 m
-----------------	-----------------	-----------------	-----------------	-----------------	-----------------	-----------------	-----------------	-----------------	-----------------

Custom made to order

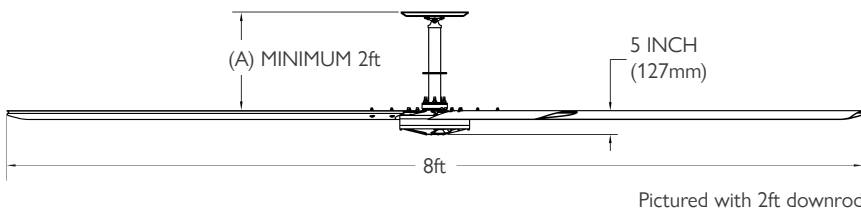

Input Power Options	<ul style="list-style-type: none"> • AC 1PH 200-240V • AC 3PH 200-240V • AC 3PH 380-480V (All 50-60Hz)
Blades Material	6005A Structural Grade Aluminium
Downrod Sizes	24" / 60cm (1 included), 36" / 91cm, 48" / 122cm, 60" / 152cm, 72" / 183cm, 84" / 213cm, 96" / 244cm, 108" / 274cm, 120" / 305cm
Warranty	15 years

DIAMETER	LOCATION	POWER	MAX. AFFECTED AREA	MAX. SPEED	NOISE	FAN MAX. WATTS	WEIGHT
14 ft / 4.3m	Indoor Only (Damp)	3/4 HP	7,744 sq. ft / 719m ²	105 RPM	<55dB	650	168 Lbs 76.2 kg
16 ft / 4.9m	Indoor Only (Damp)	1 HP	10,000 sq. ft / 930m ²	102 RPM	<55dB	1075	175 Lbs 79 kg
18 ft / 5.5m	Indoor Only (Damp)	1 HP	12,769 sq. ft / 1,186m ²	95 RPM	<55dB	1010	183 Lbs 83 kg
20 ft / 6.1m	Indoor Only (Damp)	1 HP	15,625 sq. ft / 1,451m ²	82 RPM	<55dB	820	190 Lbs 86 kg
24 ft / 7.3m	Indoor Only (Damp)	1 HP	22,500 sq. ft / 2,090m ²	70 RPM	<55dB	1065	204 Lbs 93 kg

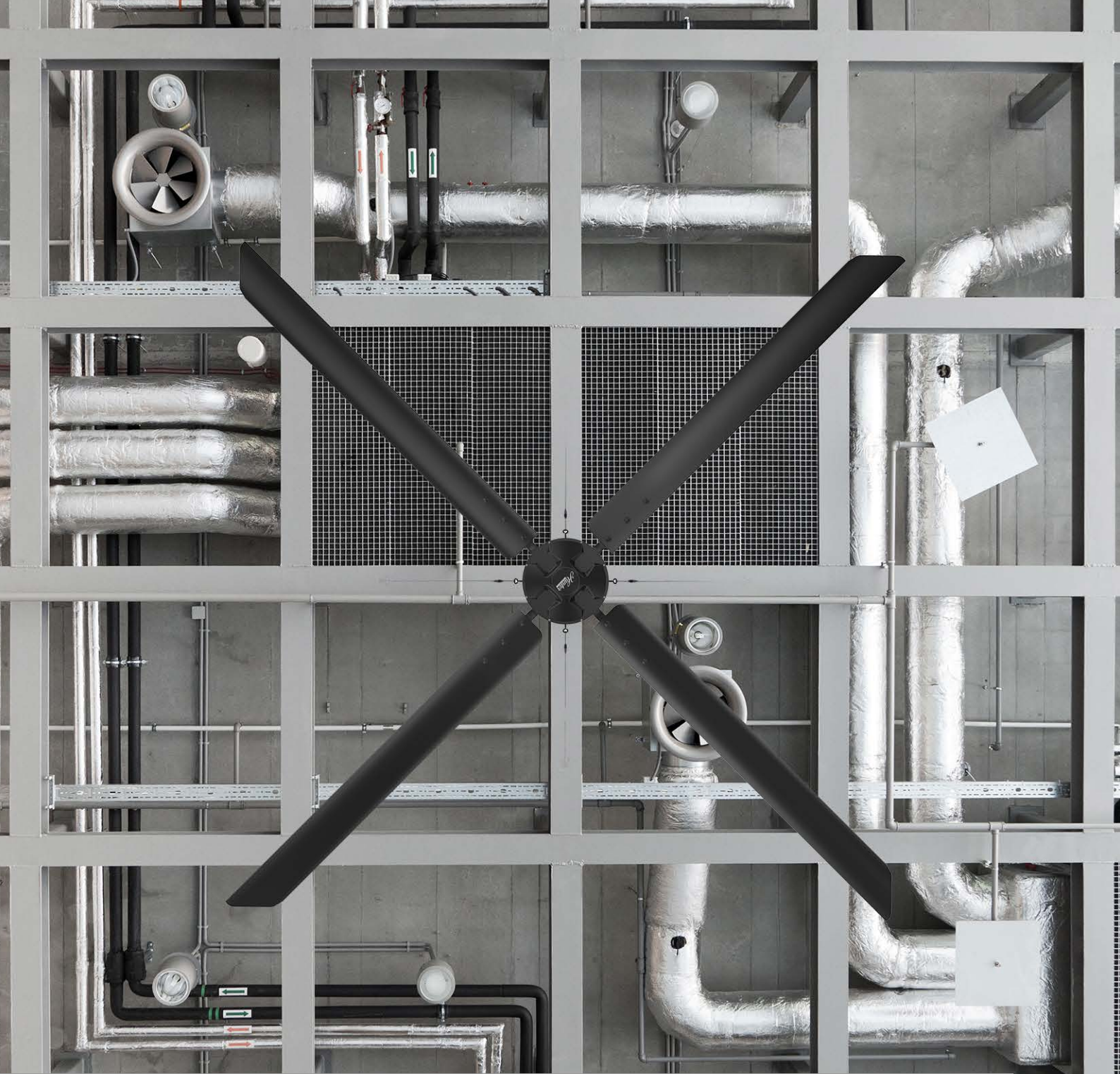

ECO

1 finish
8 sizes

Hunter industrial ECO high-volume, low-speed fan is the most lightweight and economical industrial fan in the market. With a wide range of diameters, spaces like auto shops, fitness centres, and warehouses can experience controlled temperatures. The ECO utilises a custom direct drive motor specifically designed for the industrial fan market and blades designed by aerospace engineers.

Hunter



AC

ECO



SIZES AVAILABLE



8 ft	2.5 m	10 ft	3.1 m	12 ft	3.7 m	14 ft	4.3 m
16 ft	4.9 m	18 ft	5.5 m	20 ft	6.1 m	24 ft	7.3 m

Custom made to order

Input Power Options	<ul style="list-style-type: none"> • AC 1PH 200-240V • AC 3PH 200-240V • AC 3PH 380-480V (All 50-60Hz)
Blades Material	6005A Structural Grade Aluminium. Matte Black.
Power	5/8 HP
Noise	<55dB
Downrod Sizes	24" / 60cm (1 included), 36" / 91cm, 48" / 122cm, 60" / 152cm, 72" / 183cm, 84" / 213cm, 96" / 244cm, 108" / 274cm, 120" / 305cm
Warranty	10 years

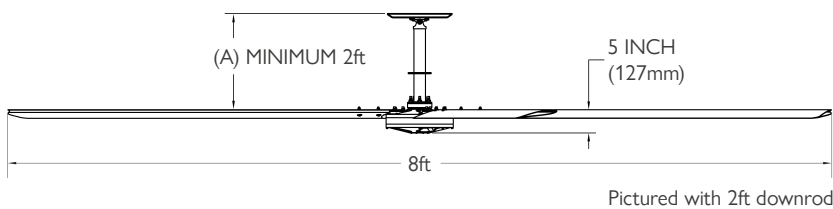

DIAMETER	LOCATION	FAN SPACING	MAX. AFFECTED AREA	MAX. SPEED	FAN MAX. WATTS	WEIGHT
8 ft / 2.5m	Indoor Only (Damp)	32 ft / 9.75m	1,600 sq. ft / 149m ²	190 RPM	455	87 Lbs / 40 kg
10 ft / 3.1m	Indoor Only (Damp)	40 ft / 12.20m	2,500 sq. ft / 232m ²	140 RPM	705	94 Lbs / 43 kg
12 ft / 3.7m	Indoor Only (Damp)	48 ft / 14.63m	3,600 sq. ft / 334m ²	110 RPM	675	101 Lbs / 46 kg
14 ft / 4.3m	Indoor Only (Damp)	56 ft / 17.07m	4,900 sq. ft / 455m ²	100 RPM	685	128 Lbs / 58 kg
16 ft / 4.9m	Indoor Only (Damp)	64 ft / 19.50m	6,400 sq. ft / 595m ²	90 RPM	795	135 Lbs / 61 kg
18 ft / 5.5m	Indoor Only (Damp)	72 ft / 22.00m	8,100 sq. ft / 753m ²	80 RPM	730	138 Lbs / 62 kg
20 ft / 6.1m	Indoor Only (Damp)	80 ft / 24.40m	10,000 sq. ft / 929m ²	70 RPM	820	145 Lbs / 66 kg
24 ft / 7.3m	Indoor Only (Damp)	96 ft / 29.30m	14,400 sq. ft / 1,338m ²	60 RPM	975	159 Lbs / 72 kg

COLOURS

When it comes to accessorising your Hunter Industrial Fan, we've got you covered. Whether you are looking for a classic colour upgrade or want to match your company's colour, our powder coat options will accentuate your space, making it all your own. Upgrades standard colours include 11 options. Your options for custom colours are as far reaching as your imaginations.



*Be sure to ask about our custom colour program

TOUCHSCREEN HMI'S AND USER INTERFACE

350 SERIES: 3.5" LCD TOUCHSCREEN DIGITAL CONTROLLER

- Basic fan control
- Daisy-chain up to 5 fans
- No additional power supply needed
- Faults displayed on screen
- Graphical animations
- Standard: TITAN, ECO
- CAT5 cable included



500 SERIES. 5" LCD DIGITAL TOUCH SCREEN CONTROLLER

- Control, group, schedule, zone up to 30 fans
- No additional power supply needed
- Password lockout
- Graphical animations
- Simple intuitive user interface
- BMS Integration with optional gateway
- Most cost effective network controller
- CAT5 cable included



BMS INTEGRATION

- Gateway allows the Fan Network to communicate to both a BAS/BMS and maintain a local HMI controller
- Status of fan is the same at the BAS/BMS and the local HMI controller
- BAS/BMS is lead and its commands will trump locally changed fan behavior at scheduled intervals
- 1 Gateway per network (30 fan maximum)
- Controls Contractor configures via web-interface



APPLICATION

FAN PLACEMENT

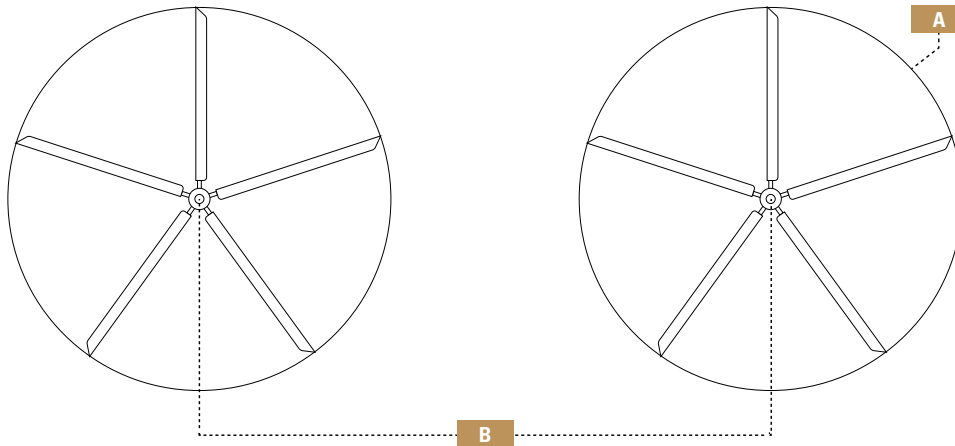

FAN SPACING CHART

ECO

A	24ft (7.3m)	20ft (6.1m)	18ft (5.5m)	16ft (4.9m)	14ft (4.3m)	12ft (3.7m)	10ft (3.1m)	8ft (2.5m)
B	96ft (29.3m)	80ft (24.4m)	72ft (21.9m)	64ft (19.5m)	56ft (17.1m)	48ft (14.6m)	40ft (12.2m)	32ft (9.8m)

TITAN

A	24ft (7.3m)	20ft (6.1m)	18ft (5.5m)	16ft (4.9m)	14ft (4.3m)
B	120ft (36.6m)	100ft (30.5m)	90ft (27.4m)	80ft (24.4m)	70ft (21.3m)

INSTALLATION TIPS



- Downrod minimum length should be 20-25% of the fan diameter installed.
 - The minimum distance from blades to floor **MUST** be 10' = 3.048m
- The optimum distance from blades to floor = 1 full diameter fan installed.
 - Minimum distance from any obstacle to blades = 2 feet.



The Ceiling Fan Company warrants Kichler ceiling fan products and component parts to the original consumer purchaser or commercial purchaser, as applicable, to be free from defects in material and workmanship for the applicable period specified below.

CEILING FAN MOTOR OR MOTOR-RELATED PARTS

For the lifetime of the ceiling fan, which is reasonably considered to be ten (10) years, from the date of purchase.

LED LIGHT ENGINES AND ELECTRICAL COMPONENTS

Five (5) years from the date of purchase when the ceiling fan containing the LED light engine and electrical components is installed for residential or commercial use by the original consumer purchaser. For commercial purchasers, the warranty period is three (3) years from the date of purchase.

OTHER PARTS

Two (2) year from the date of purchase of the ceiling fan. Covered parts include, but are not limited to, blades, remote controls, down rods, components, housing, or finish. (Finish is subject to how and where the fan is used).

WHAT WE WILL DO

The Ceiling Fan Company, or our trade dealer, at their sole discretion, will repair or replace, free of charge, during the applicable warranty period, any product or component part (as described above) that proves defective in material and/or workmanship under normal installation, use and service. If repair or replacement is not practical, Your supplier may elect to refund the purchase price in exchange for the return of the product. Replacement parts are subject to availability and may differ from those originally supplied. These are your exclusive remedies.

WHAT IS NOT COVERED

The following carry no warranty other than the manufacturer's warranty:

Light bulbs supplied by, but not manufactured by, The Ceiling Fan Company.

This warranty does not cover brass finishes on the products described above, as they are likely to naturally age or tarnish. This warranty does not cover damage resulting from reasonable wear and tear, voltage outside of the standard 220-240v (50hz) range, misuse (including use of the product for an unintended application), abuse, improper packaging of product returned to The Ceiling Fan Company, neglect and improper or incorrect installation, maintenance or repair, including failure to follow the applicable care and cleaning instructions. The Ceiling Fan Company recommends using a professional electrician for all installation and repair of its products. The warranty will not cover replacement installation costs.

WHAT YOU MUST DO TO OBTAIN WARRANTY SERVICE OR REPLACEMENT PARTS

Please contact the distributor or retailer from whom you purchased the product with full details of your fan, proof of purchase and the defect observed. If it is agreed by your supplier, a warranty claim may be made by returning the product along with the proof of purchase (original sales receipt) and a written claim briefly describing the defect.

If the distributor or retailer is not available, or if you have questions about this warranty, please contact us by mail or online as follows (please include your model number and date of purchase):

The Ceiling Fan Company L.L.C., P.O. Box 282188, Dubai, United Arab Emirates

www.theceilingfancompany.com/contact-us/

LIMITATION ON DURATION OF IMPLIED WARRANTIES

Note: Some countries do not allow limitations on how long an implied warranty lasts, so the below limitation may not apply to you. TO THE EXTENT PERMITTED BY LAW, ANY IMPLIED WARRANTY, INCLUDING THE IMPLIED WARRANTIES OF MERCHANTABILITY AND OF FITNESS FOR A PARTICULAR PURPOSE, IS LIMITED TO THE STATUTORY PERIOD OR THE DURATION OF THIS WARRANTY, WHICHEVER IS SHORTER.

LIMITATION OF SPECIAL, INCIDENTAL OR CONSEQUENTIAL DAMAGES

Note: Some countries do not allow the exclusion or limitation of special, incidental or consequential damages, so the below limitations and exclusions may not apply to you. THE CEILING FAN COMPANY SHALL NOT BE LIABLE FOR ANY SPECIAL, INCIDENTAL OR CONSEQUENTIAL DAMAGES (INCLUDING LABOR CHARGES TO REPAIR, REPLACE, INSTALL OR REMOVE THIS PRODUCT), WHETHER ARISING OUT OF BREACH OF ANY EXPRESS OR IMPLIED WARRANTY, BREACH OF CONTRACT, TORT, OR OTHERWISE.

ADDITIONAL RIGHTS

This warranty gives you specific legal rights. You may also have other rights which vary by country. This warranty is not transferable.



LIMITED LIFETIME MOTOR WARRANTY ON HUNTER® CEILING FANS

EXPRESS MANUFACTURER'S GUARANTEE

This Hunter Fan Ceiling Fan or Hunter pole mounted Ceiling Fan ("Ceiling Fan") is guaranteed by the Hunter Fan Company of 2500 Frisco Avenue, Memphis, Tennessee 38114, United States of America ("Hunter"/"we"/"us") for the benefit of the original user or consumer purchaser ("You") against defects in material or workmanship ("Defect"):

1. At any time following purchase if such a Defect occurs in relation to the motor of the Ceiling Fan;
2. For or a period of two years after the date of purchase for any other Defect. If such a Defect occurs, Hunter will repair or, at our option, replace the Defective part free of charge. Labour to repair the Defective part will, likewise, be provided free of charge.

As part of our desire to improve our products, we may, from time to time, change the products within our range or their component parts. Therefore, if you make a claim under this Guarantee and an identical part or product is not available, we may replace a Ceiling Fan (or any part of that Ceiling Fan) that has a Defect with a similar product (or part) of the same or improved specification.

This Guarantee relates solely to Defects to the Ceiling Fan.

WHAT IS NOT COVERED

This guarantee does not extend to glass globes, light bulbs or to the finish on any metal portion of the Ceiling Fan. The Guarantee does not cover any damage caused to any property by a defective Ceiling Fan.

This guarantee will not apply if:

- (a) The Ceiling Fan is not purchased and installed in the Middle East or Levant.
- (b) The Ceiling Fan is not installed correctly in accordance with Hunter's specifications or instructions; or
- (c) Any fault, defect, loss, damage, injury or claim results from the improper or incorrect use of the Ceiling Fan, improper repairs of the Ceiling Fan by non-authorised persons, the direct or indirect acts of a third party, or any other reason whatsoever with the exception of a Defect in your Ceiling Fan.

The guarantee will no longer be effective if:

- You cease to own the Ceiling Fan
- The Ceiling Fan is moved from the initial location in which it is fitted

HOW DO YOU CLAIM UNDER THIS GUARANTEE?

If you wish to claim under this Guarantee please return the Ceiling Fan to the retailer from where you initially purchased the Ceiling Fan or alternatively to our authorised distributor in the Middle East and Levant, The Ceiling Fan Company LLC (tel: 971 4 366 3961). Your Ceiling Fan should be properly packed to avoid damage in transit and we will not be responsible for any such damage that occurs if you fail to do this. You must provide your sales receipt or other document establishing proof of purchase when claiming under the Guarantee.

STATUTORY RIGHTS

This Guarantee is in addition to, and in no way affects, Your statutory rights.

BUSINESS USE

If you have bought this Ceiling Fan acting in the course of your business, trade or profession, then this Guarantee is in place of and to the extent permitted by law replaces and excludes all other warranties and conditions whether express or implied by common law, statutory or otherwise.

GOVERNING LAW

This guarantee is to be construed in accordance with United Arab Emirates law.

FOR ADDITIONAL INFORMATION REGARDING THE DESIGN CRAFT, PLEASE REFER TO OUR WEBSITE AT: www.hunterfan.com



INDEX

Ahrendale	130	Hatteras Bay	50	Protos	82
Arcot	98, 100	Imari	24	Ridley II	64
Bayport	112	Industrie II	78	Ried	44
Builder Elite	68	Jade	36	Savoy	72
Cabo Frio	90	Kevlar	132, 158	Seville II	104
Canfield	120	Lehr	128	Sola	160
Colerne	66	Lehr II	142	Sonic	58
Dante	108	Link	52	Stile	94
Eco (industrial)	178	Loki	86	Terna	122
Eris	134	Low Profile III	102	Titan (industrial)	176
Ferron	26	Patio	148	Trak (commercial)	170
Finley	116	Maribel	144	Trimaran	154
Gentry	22	Monarch II	62	Voya	30
Gentry XL	20	Outdoor Elements II	138, 150	Xety	46
Harmony	54	Phree	40	Zeus	32





We sell fans by:

KICHLER

Hunter
SINCE 1886

Contact Us:

HEAD OFFICE

The Ceiling Fan Company L.L.C.,
P.O. Box 282188,
Dubai, United Arab Emirates
T: +971 4 388 3025
F: +971 4 388 3031
E: info@theceilingfancompany.com

JORDAN SALES OFFICE

T: +962 79 561 4441
E: christine@elsteadlighting.com

www.theceilingfancompany.com